

# SPECIFICATIONS OF CITILIGHT

1 / 11

**1. Scope of Application**

These specifications apply to chip type LED lamp, CITILIGHT, model CL-822-U1D-T.

**2. Part code**

C L - 8 2 2 - U 1 D - T

Series \_\_\_\_\_

822 : White LED for general lighting.

Watt Class \_\_\_\_\_

U1 : Under 1 watt package.

Lighting Color \_\_\_\_\_

D : White color

Shipping mode \_\_\_\_\_

Non-coded : Bulk

T : Taping (standard)

			Approve	Checked	Drawn	Symbol	CITILIGHT
			Jun.12.'08	Jun.12.'08	Jun.12.'08	Name	CL-822-U1D
			K.Fukasawa	K.Sasuga	Y.Otaki	Drawing No	
Mark	Date	Description	Appro. CITIZEN ELECTRONICS CO.,LTD.				

3. Outline drawing

Unit: mm  
Tolerance: ±0.1

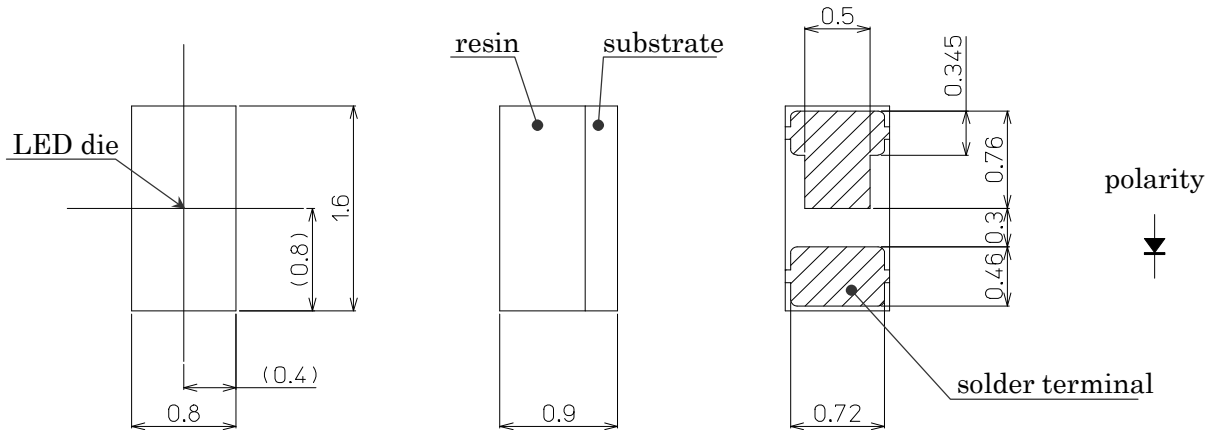

4. Performance

(1) Absolute Maximum Rating

Parameter	Symbol	Rating Value	Unit
Power Dissipation	$P_d$	108	mW
Forward Current	$I_F$	30	mA
Forward Pulse Current	$I_{FP}$	100 *	mA
Reverse Voltage	$V_R$	5	V
Operating Temperature	$T_{op}$	-30 ~ +85	°C
Storage Temperature	$T_{st}$	-40 ~ +100	°C
Junction Temperature	$T_J$	120	°C

\*Duty ≤ 1/10, Pulse width ≤ 0.1 msec

\* $T_J = T_s + R_{J-s} \times P_d$  (D.C.driving) ※ $T_s$ : Temperature of anode solder terminal

			Approve	Checked	Drawn	Symbol	CITILIGHT
			Jun.12.'08	Jun.12.'08	Jun.12.'08	Name	CL-822-U1D
			K.Fukasawa	K.Sasuga	Y.Otaki	Drawing No	
Mark	Date	Description	Appro.	CITIZEN ELECTRONICS CO.,LTD.			

(2) Electro-optical Characteristic

Parameter	Symbol	Condition	MIN	TYP	MAX	Unit
Forward Voltage	$V_F$	$I_F=20mA$	3	3.2	3.6	V
Reverse Current	$I_R$	$V_R=5V$	-	-	100	$\mu A$
Thermal resistance	Rj-s	Junction-Solder	-	170	-	$^{\circ}C/W$
Luminous Intensity*1	$I_V$	$I_F=20mA$	830	1080	-	mcd
Luminous Flux	$\Phi_v$	$I_F=20mA$	-	(5.4)	-	lm

\*1 In accordance with NIST standard

Ranking (Condition :  $I_F=20mA$  ,  $T_a=25^{\circ}C$ )

Parameter	Symbol	Rank	Min	Max	Unit
Forward Voltage	$V_F$	Q	3.0	3.2	V
		R	3.2	3.4	
		S	3.4	3.6	
Luminous Intensity	$I_V$	H1	830	1082	mcd
		J1	1082	1294	
		K1	1294	1544	
		L1	1544	1844	

Chromaticity coordinates (Condition :  $I_F=20mA$  ,  $T_a=25^{\circ}C$ )

Color Rank	x	y	Color Rank	x	y
DR1	0.303	0.333	DR4	0.317	0.327
	0.301	0.342		0.315	0.345
	0.314	0.356		0.331	0.360
	0.315	0.345		0.331	0.340

Color Rank	x	y	Color Rank	x	y
DR2	0.315	0.345	DR5	0.310	0.302
	0.314	0.356		0.307	0.316
	0.331	0.373		0.317	0.327
	0.331	0.360		0.319	0.311

Color Rank	x	y	Color Rank	x	y
DR3	0.307	0.316	DR6	0.331	0.340
	0.303	0.333		0.317	0.327
	0.315	0.345		0.319	0.311
	0.317	0.327		0.331	0.322

Note 1) The tolerance of measurement at our tester is  $V_F \pm 3\%$  ,  $I_V / \Phi_v \pm 10\%$  , Chromaticity(x,y) $\pm 0.01$ .

Note 2) For handling ,please apply CMOS LSI or equivalent any electrostatic effect.

Measurement Conditions

- 1) Chip is mounted on board( size 100mm×40mm)
- 2) Board material is FR-4, covered with green color resist and thickness of copper is 18 $\mu m$ .

			Approve	Checked	Drawn	Symbol	CITILIGHT
			Jun.12.'08 K.Fukasawa	Jun.12.'08 K.Sasuga	Jun.12.'08 Y.Otaki	Name	CL-822-U1D
						Drawing No	
Mark	Date	Description	Appro.	CITIZEN ELECTRONICS CO.,LTD.			

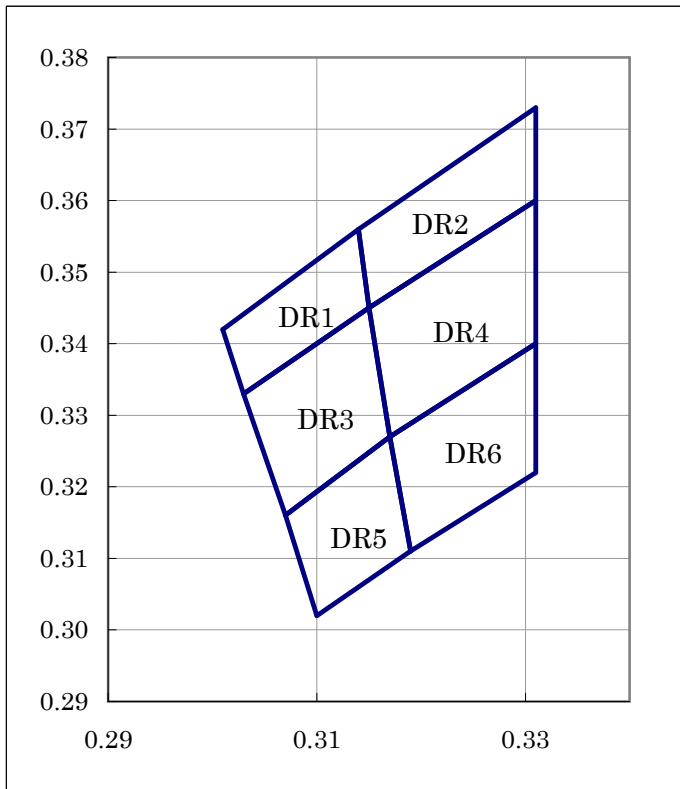

Rank information



**CUSTOMER:**  
**TYPE:** CL-822-U1D  
**P.NO:**  
**Lot No:** XXXXXX  
**Q'ty:** XXX







PASS



CITIZEN ELECTRONICS

e.g.  $\frac{J1 \quad DR1 \quad Q}{\downarrow}$   
 J1    D1    Q  
  

-   : Ranking by Luminous Intensity
-   : Ranking by Chromaticity coordinates
-  : Ranking by Forward Voltage

			Approve	Checked	Drawn	Symbol	CITILIGHT
			Jun.12.'08	Jun.12.'08	Jun.12.'08	Name	CL-822-U1D
			K.Fukasawa	K.Sasuga	Y.Otaki	Drawing No	
Mark	Date	Description	Appro.	CITIZEN ELECTRONICS CO.,LTD.			

5. Characteristic

$T_a=25^{\circ}\text{C}$

$T_a=25^{\circ}\text{C}$

Forward Current vs. Relative Luminous Intensity

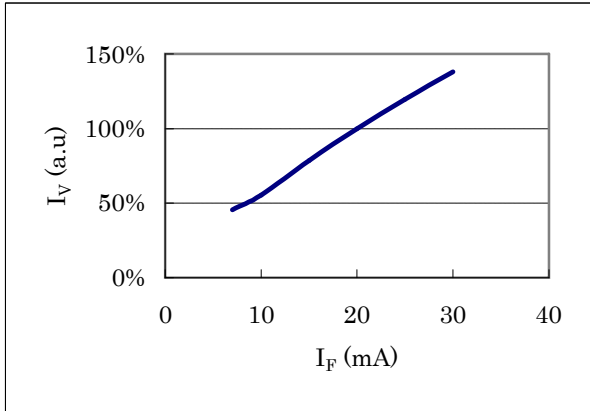

Forward Current vs. Forward Voltage

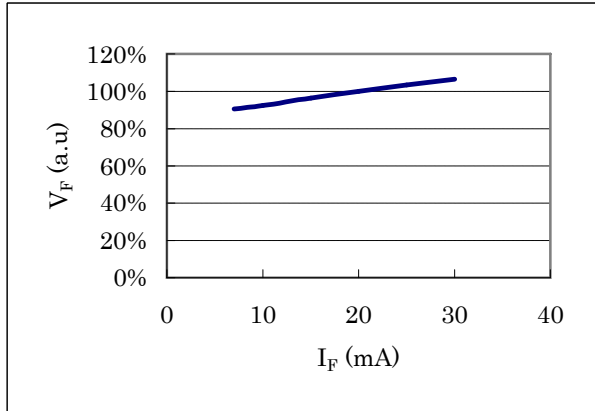

$I_F=20\text{mA}$

$I_F=20\text{mA}$

Ambient Temperature vs. Relative Luminous Intensity

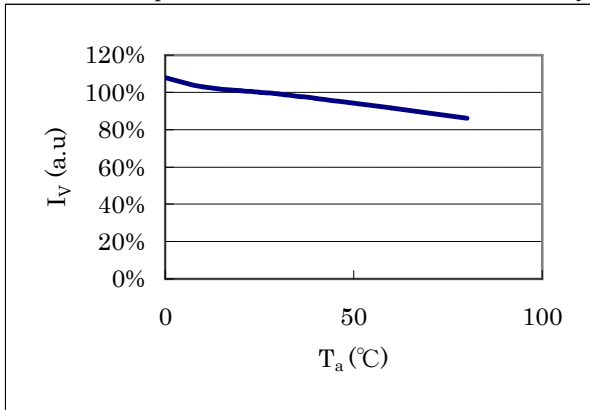

Ambient Temperature vs. Forward Voltage

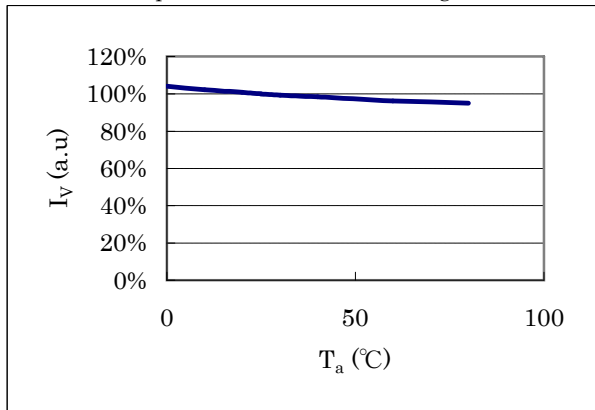

Ambient Temperature vs. Maximum Forward Current

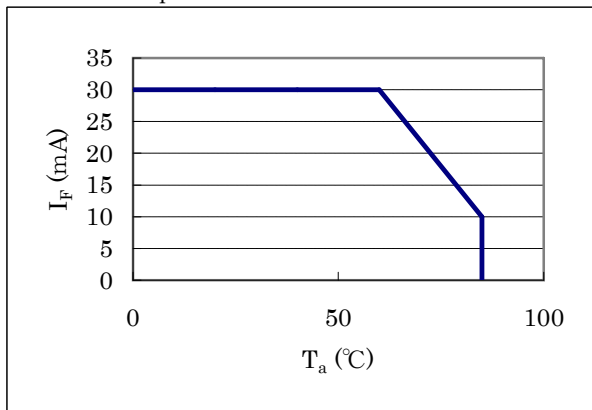

			Approve	Checked	Drawn	Symbol	CITILIGHT	
			Jun.12.'08	Jun.12.'08	Jun.12.'08	Name	CL-822-U1D	
			K.Fukasawa	K.Sasuga	Y.Otaki	Drawing No		
Mark	Date	Description	APPRO. _____					CITIZEN ELECTRONICS CO.,LTD.

5. Characteristic

$T_a=25^{\circ}\text{C}$

$I_F=20\text{mA}$

Forward Current vs.Chromaticity Shift

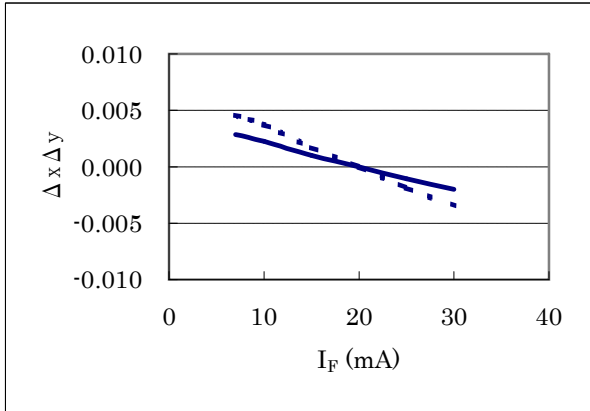

Ambient Temperature vs.Chromaticity Shift

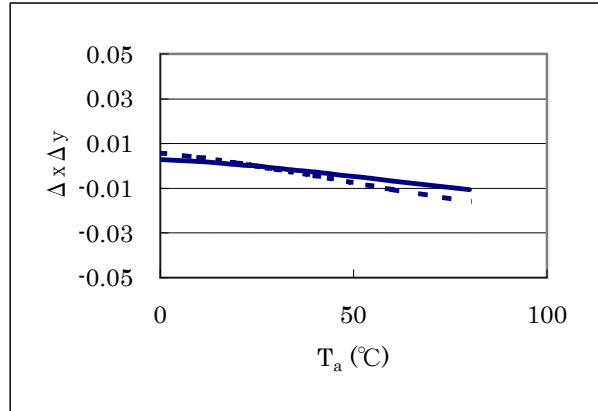

Directive Characteristic

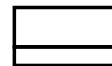
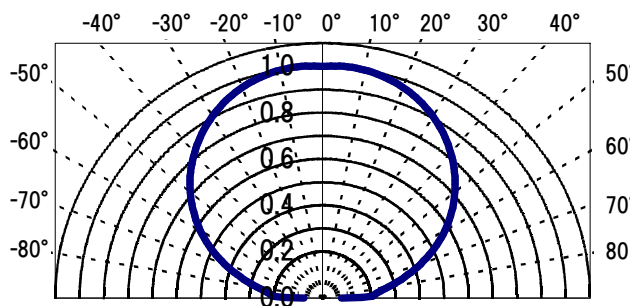
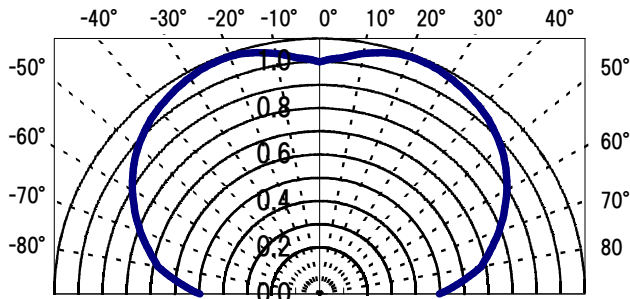

			Approve	Checked	Drawn	Symbol	CITILIGHT
			Jun.12.'08	Jun.12.'08	Jun.12.'08	Name	CL-822-U1D
			K.Fukasawa	K.Sasuga	Y.Otaki	Drawing No	
Mark	Date	Description	Appro.	CITIZEN ELECTRONICS CO.,LTD.			

6. Reliability

(1) Details of the tests

Test Item	Test Condition
Life Test in Continuous Operation	25±3°C, I <sub>F</sub> =20 mA × 1000+24/-12hours
Low Temperature Storage Test	-40+3/-5°C × 1000+24/-12hours
High Temperature Storage Test	100+5/-3°C × 1000+24/-12hours
Moisture-proof Test	60 ±2°C, 90 ±5%RH for 1000+24/-12hours
Thermal Shock Test	-40°C × 30 minutes and 100°C × 30 minutes, 100cycle
Solder Heat Resistance Test	Recommended temperature profile (reflow soldering) × 2, (2nd test must be started after the samples are stabilized thermally.)

(2) Judgment Criteria of Failure for Reliability Test

Measuring Item	Symbol	Measuring Condition	Judgement Criteria for Failure
Forward Voltage	V <sub>F</sub>	I <sub>F</sub> =20mA	> U×1.2
Forward Current	I <sub>F</sub>	V <sub>F</sub> =5V	> U×2
Luminous Intensity	I <sub>V</sub>	I <sub>F</sub> =20mA	< S×0.7

U means the upper limit of the specified characteristics. S means the initial value.

Note: Measurement shall be taken between 2 hours and 24 hours, having returned the test pieces to the normal ambient conditions after the completion of each test.

			Approve	Checked	Drawn	Symbol	CITILIGHT
			Jun.12.'08	Jun.12.'08	Jun.12.'08	Name	CL-822-U1D
			K.Fukasawa	K.Sasuga	Y.Otaki	Drawing No	
Mark	Date	Description	Appro.	CITIZEN ELECTRONICS CO.,LTD.			

7. Taping Specifications (in accordance with JIS standard)

(1) Shape and Dimensions of Reel

(Unit: mm)

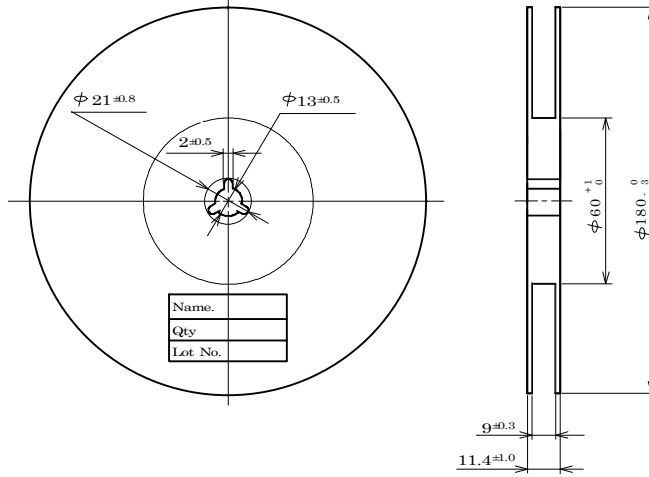

(2) Dimensions of Tape

(Unit: mm)

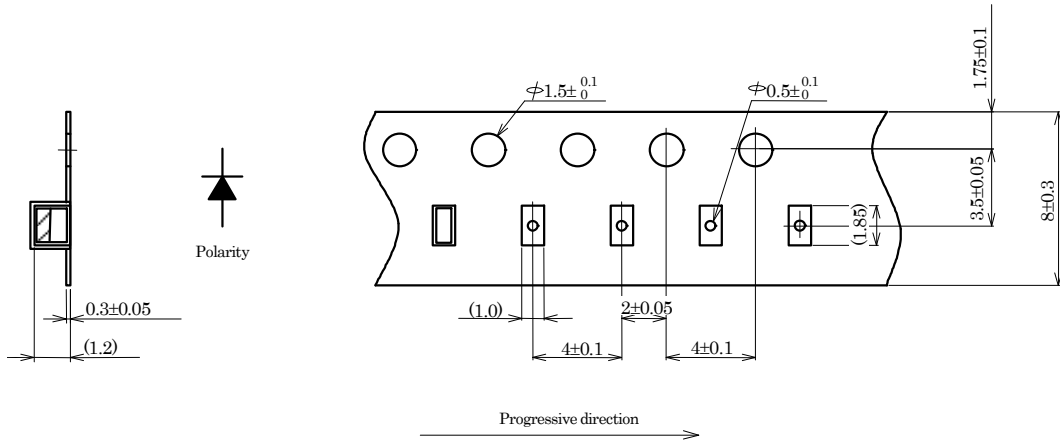

(3) Configuration of Tape

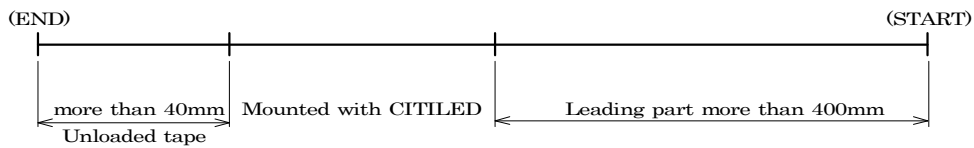

(4) Quantity: 2500pcs/reel

			Approve	Checked	Drawn	Symbol	CITILIGHT
			Jun.12.'08	Jun.12.'08	Jun.12.'08	Name	CL-822-U1D
			K.Fukasawa	K.Sasuga	Y.Otaki	Drawing No	
Mark	Date	Description	Appro.	CITIZEN ELECTRONICS CO.,LTD.			

8. Packing Specifications

8-1. Moisture-proof Packing

To prevent moisture absorption during transportation and storage, reels are packed in aluminum envelopes which contain a desiccant with a humidity indicator.

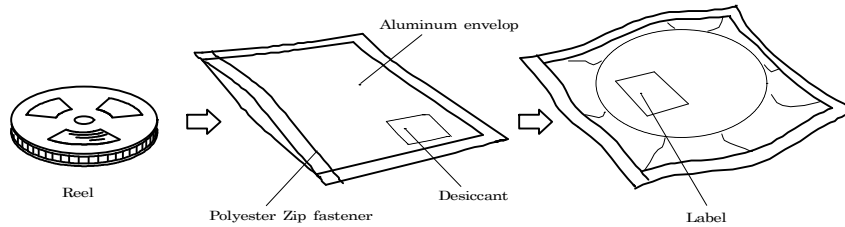

8-2. Storage

To prevent moisture absorption, it is strongly recommended that reels (in bulk or taped) should be stored in the dry box (or the desiccator) with a desiccant as the appropriate storage place. If not, the following is recommended.

Temperature: 5 ~ 30 °C  
 Humidity: 60%RH max

The devices should be mounted as soon as possible after unpacking. If you store the unpacked reels, please store them in the dry box or seal them into the envelop again.

8-3. Baking

If the devices have been stored over 6 months or unpacked over 7 days, it should be baked under the following conditions.

Baking conditions 60°C × 12 hours or more (reeled one)  
 100°C × 45 minutes or more (loose one)

			Approve	Checked	Drawn	Symbol	CITILIGHT
			Jun.12.'08	Jun.12.'08	Jun.12.'08	Name	CL-822-U1D
			K.Fukasawa	K.Sasuga	Y.Otaki	Drawing No	
Mark	Date	Description	Appro.	CITIZEN ELECTRONICS CO.,LTD.			

9. Precautions

9-1. Soldering

(1) Lead free soldering

1) Following soldering paste is recommended

Melting temperature: 216 ~ 220°C.

Composition: Sn 3.5Ag 0.75Cu

2) The temperature profile at the top surface of the parts is recommended as shown below.

3) It is requested that products should be handled after their temperature has dropped down to the normal room temperature

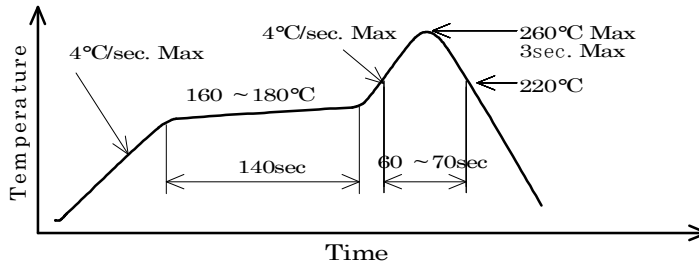

9-2. Washing

(1) When washing after soldering is needed, following conditions are requested.

a) Washing solvent: Pure Water

b) Temperature, time: 50°C or less × 30 seconds max.  
or 30°C or less × 3 minutes max.

c) Ultrasonic washing: 300W or less

9-3. Other directions

(1) It is requested to avoid any stress added to the resin portion while it is heated.

(2) It is requested to avoid any friction by sharp metal nail etc. to the resin portion.

			Approve	Checked	Drawn	Symbol	CITILIGHT
			Jun.12.'08	Jun.12.'08	Jun.12.'08	Name	CL-822-U1D
			K.Fukasawa	K.Sasuga	Y.Otaki	Drawing No	
Mark	Date	Description	Appro.	CITIZEN ELECTRONICS CO.,LTD.			

10. Designing precautions

- (1) The current limiting resistor should be placed in the circuit so that is driven within its rating. Also avoid reverse voltage (over-current) applied instantaneously when ON or OFF.
- (2) When pulse driving current is applied, average current consumption should be within the rating. Also avoid reverse voltage applied when put off.
- (3) Recommended soldering pattern

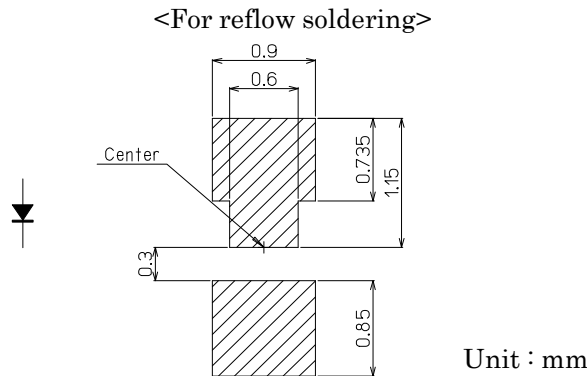

The above dimensions are not the one which guarantee the performance of mountability. The use of the above pattern is recommended to use after deep study at your site.

- (4) When assembling the circuit board into the finished products, care must be taken to avoid the component parts from touching other parts.
- (5) When using multiple LEDs, it is required to connect a current limiting resistor on each path which the current flows to the LEDs.

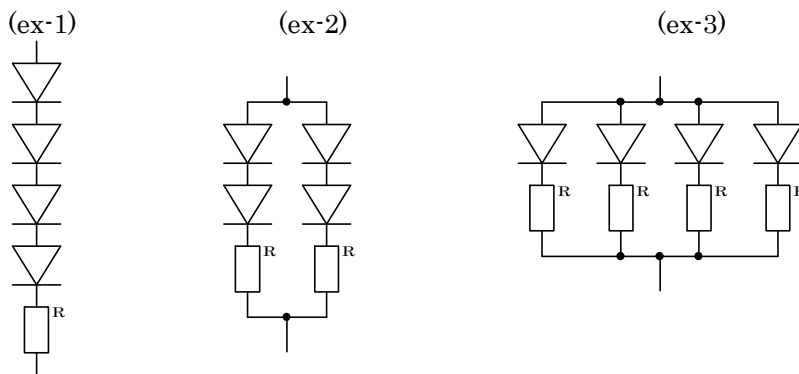

- (6) Other
  - 1) This product complies with RoHs directives.
  - 2) When this product is secondarily fabricated such as change in shape, it is not included in our warranty.
  - 3) The agreement of formal product specifications is required prior to mass production.

			Approve	Checked	Drawn	Symbol	CITILIGHT
			Jun.12.'08 K.Fukasawa	Jun.12.'08 K.Sasuga	Jun.12.'08 Y.Otaki	Name	CL-822-U1D
						Drawing No	
Mark	Date	Description	Appro.	CITIZEN ELECTRONICS CO.,LTD.			