

# SPECIFICATIONS

1/11

**1. Scope of Application**

These specifications are applied to the chip type LED lamp , model CL-824-MU1WW1-T

**2. Part code**

## CL - 824 - MU1 WW1 - T

Series

824 : White LED for general lighting.

Special specifications

M : General Color Rendering Index Typ. 85 Type.

Watt Class

U1 : Under 1 watt package.

Lighting color

WW1 : Energy Star Correlated Color Temperature 3500(K)

Shipping mode

Non-coded : Bulk

T : Taping (standard)

			Approved	Checked	Drawn	Symbol	CITILIGHT
						Name	CL-824-MU1WW1
						Drawing No	
Mark	Date	Description	Appro.	CITIZEN ELECTRONICS CO.,LTD.			

# SPECIFICATIONS

2/11

### 3. Outline drawing

Unit: mm  
Tolerance: ±0.1



### 4. Performance

#### ( 1 ) Absolute Maximum Rating

Parameter	Symbol	Rating Value	Unit
Power Dissipation	Pd	108	mW
Forward Current	I <sub>F</sub>	30	mA
Forward Pulse Current	I <sub>FP</sub>	100 *	mA
Reverse Voltage	V <sub>R</sub>	5	V
Operating Temperature	T <sub>OP</sub>	-30 ~ +85	C
Storage Temperature	T <sub>ST</sub>	-40 ~ +100	C
Junction Temperature	T <sub>j Max</sub>	120	C

\*1 Forward Current : Duty ≤ 1/10 , Pulse Width ≤ 0.1msec

\*2 D.C. Current : T<sub>j</sub> = T<sub>c</sub> + R<sub>j-c</sub> × Pd

Pulse Current : T<sub>j</sub> = T<sub>c</sub> + R<sub>j-c</sub> × Pw (Power Dissipation / one-Pulse) × duty

※T<sub>s</sub>: Temperature of anode solder terminal

			Approved	Checked	Drawn	Symbol	CITILIGHT
						Name	CL-824-MU1WW1
						Drawing No.	
Mark	Date	Description	Appro.	CITIZEN ELECTRONICS CO.,LTD.			

# SPECIFICATIONS

3/11

## ( 2 ) Electro-optical Characteristics ( Tc=25C )

Parameter	Symbol	Condition	MIN	TYP	MAX	Unit
Forward Voltage	$V_F$	$I_F=20mA$	2.8	3.2	3.5	V
Reverse Current	$I_R$	$V_R=5V$	-	-	100	$\mu A$
Thermal resistance	$R_{J-S}$	Junction-solder	-	175	-	C/W
Luminous Intensity <sup>*1</sup>	$I_v$	$I_F=20mA$	1140	1530	-	mcd
Luminous Flux	$\phi_v$	$I_F=20mA$	-	(4.3)	-	lm
High General Color Rendering Index	Ra	$I_F=20mA$	80	85	-	-

\*1 In accordance with NIST standard

### Ranking (Condition : $I_F=20mA$ , $T_a=25C$ )

Parameter	Symbol	Rank	MIN	MAX	Unit
Forward Voltage	$V_F$	Q	2.8	3.0	V
		R	3.0	3.2	
		S	3.2	3.5	
Luminous Intensity	$I_v$	B	1140	1300	mcd
		C	1300	1759	
		D	1759	1912	

### Chromaticity coordinates

( Condition :  $I_F=20mA$  ,  $T_c=25C$  )

Color Rank	x	y
WW1	0.4299	0.4165
	0.3996	0.4015
	0.3889	0.3690
	0.4147	0.3814

Note 1) The tolerance of measurement at our tester is  $V_F \pm 3\%$  ,  $\phi_v \pm 10\%$  , Chromaticity(x,y) $\pm 0.01$ .

Note 2) For handling ,please apply CMOS LSI or equivalent any electrostatic effect.

			Approved	Checked	Drawn	Symbol	CITILIGHT
						Name	CL-824-MU1WW1
						Drawing No	
Mark	Date	Description	APPRO. CITIZEN ELECTRONICS CO.,LTD.				

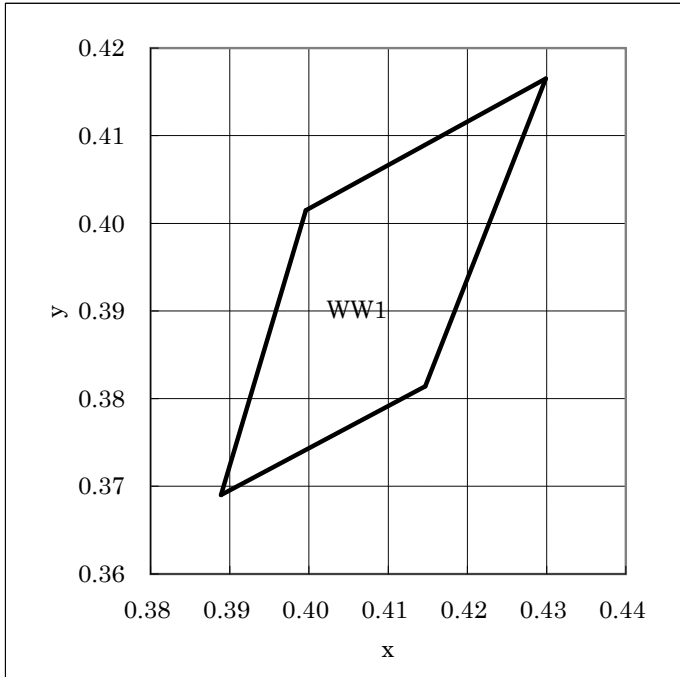

Rank information

**CUSTOMER:**  
**TYPE:** CL-824-MU1WW1  
**P.NO:**  
**Lot No:** XXXXXX  
**Q'ty:** XXX



PASS



CITIZEN ELECTRONICS

e.g. B WW1 Q



- : Ranking by Luminous Intensity
- △△ : Ranking by Chromaticity coordinates
- : Ranking by Forward Voltage

			Approved	Checked	Drawn	Symbol	CITILIGHT
						Name	CL-824-MU1WW1
						Drawing No	
Mark	Date	Description	Appr.	CITIZEN ELECTRONICS CO.,LTD.			

# SPECIFICATIONS

5/11

## 5. Characteristics

Forward Current vs. Relative Luminous Intensity

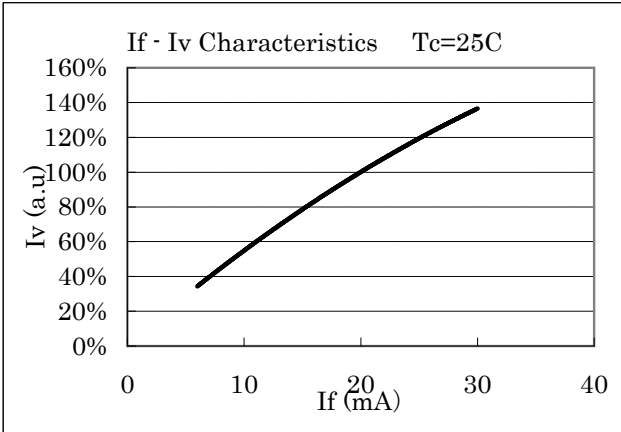

Forward Current vs. Forward Voltage

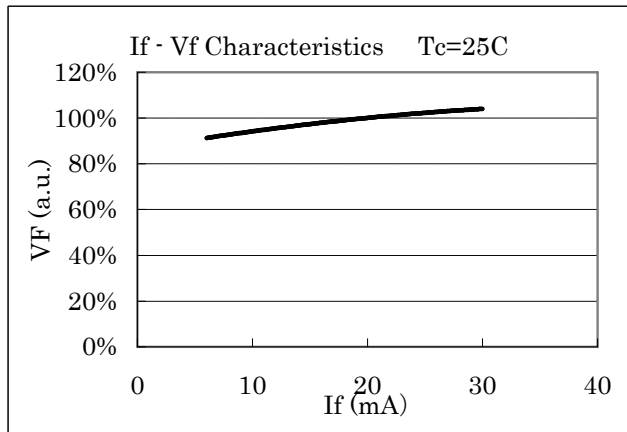

Forward Current vs. Chromaticity Coordinate

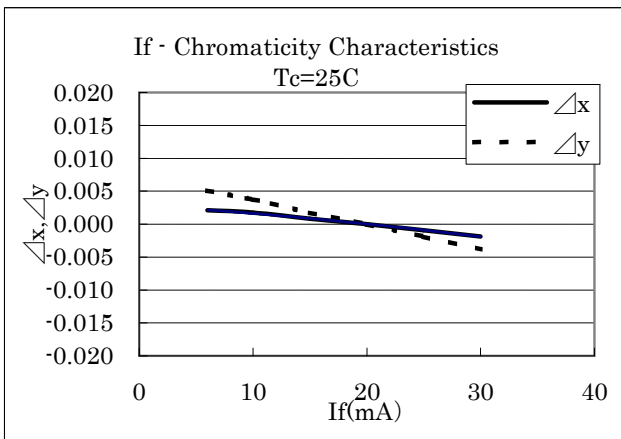

Case Temperature vs. Chromaticity Coordinate

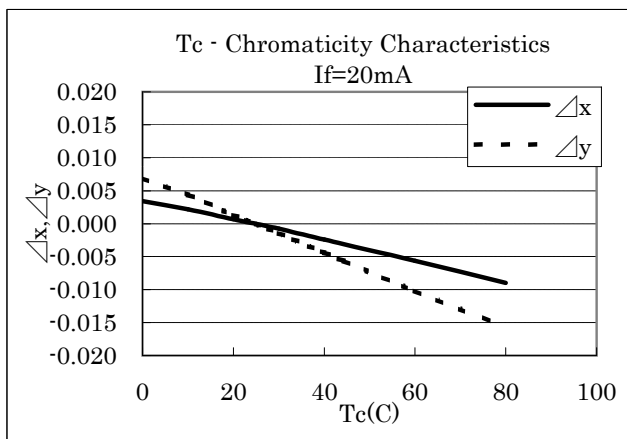

Case Temperature vs. Forward Voltage

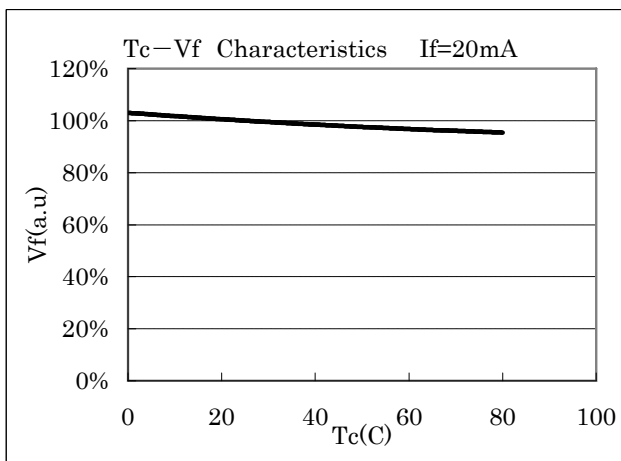

Case Temperature vs. Relative Luminous Intensity

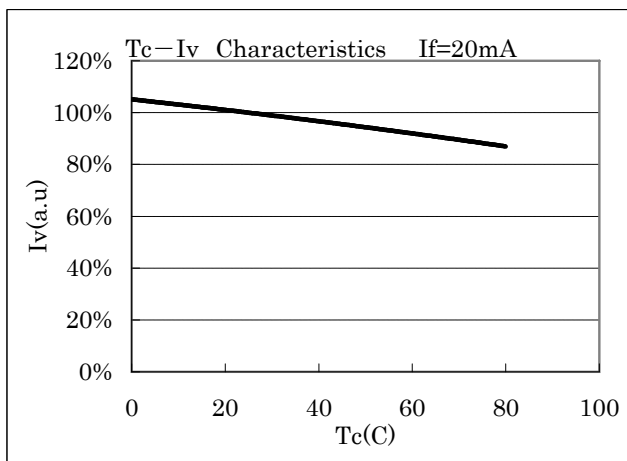

			Approved	Checked	Drawn	Symbol	CITILIGHT
						Name	CL-824-MU1WW1
						Drawing No	
Mark	Date	Description	Appr.	CITIZEN ELECTRONICS CO.,LTD.			

# SPECIFICATIONS

6/11

Case Temperature vs. Allowable Forward Current

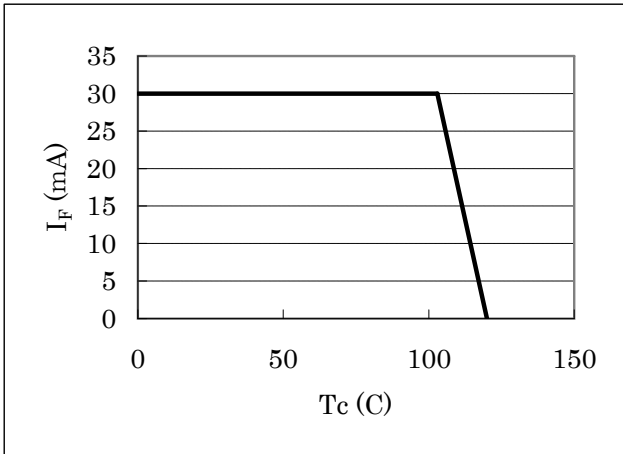

Spectrum

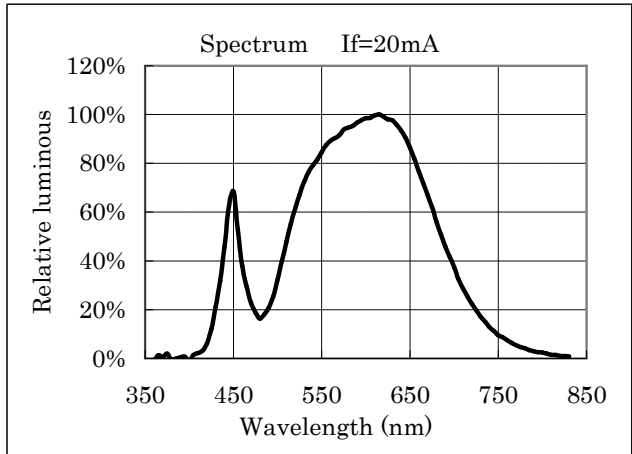

Directive Characteristic

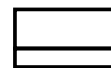
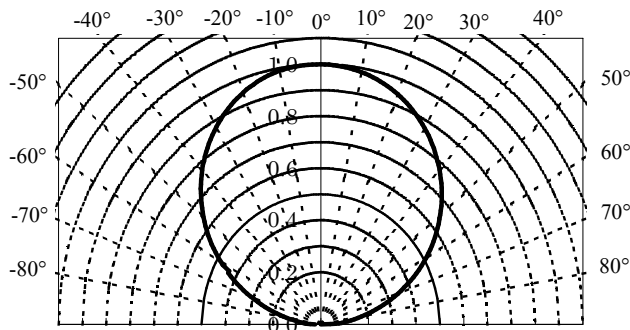
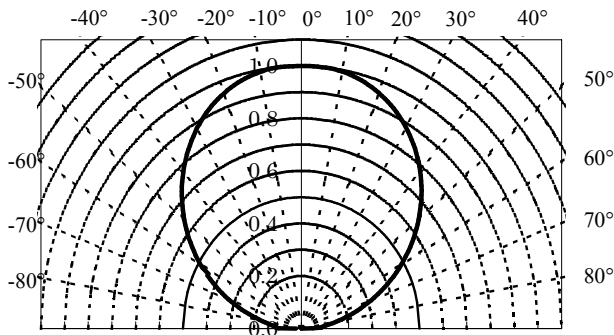

			Approved	Checked	Drawn	Symbol	CITILIGHT
						Name	CL-824-MU1WW1
						Drawing No	
Mark	Date	Description	Appr.	CITIZEN ELECTRONICS CO.,LTD.			

# SPECIFICATIONS

7/11

## 6. Reliability

### (1)Details of the tests

Test Item	Test Condition
Life Test in Continuous Operation	25±3C, I <sub>F</sub> =20 mA , 1000+24/-12hours
Low Temperature Storage Test	-40+3/-5C , 1000+24/-12hours
High Temperature Storage Test	100+5/-3C , 1000+24/-12hours
Moisture-proof Test	60 ±2°C, 90 ±5%RH for 1000+24/-12hours
Thermal Shock Test	-40C , 30 minutes and 100C , 30 minutes, 100cycle
Solder Heat Resistance Test	Recommended temperature profile (reflow soldering) × 2, (2nd test must be started after the samples are stabilized thermally.)

### (2)Judgment Criteria of Failure for Reliability Test

(T<sub>a</sub>=25C)

Measuring Item	Symbol	Measuring Condition	Judgment Criteria for Failure
Forward Voltage	V <sub>F</sub>	I <sub>F</sub> =20mA	>U×1.2
Reverse Current	I <sub>R</sub>	V <sub>R</sub> =5V	>U×2
Luminous Intensity	I <sub>V</sub>	I <sub>F</sub> =20mA	<S×0.7

U defines the upper limit of the specified characteristics.S defines the initial value.

Note: Measurement shall be taken between 2 hours and 24 hours, and the test pieces should be returned to the normal ambient conditions after the completion of each test.

			Approved	Checked	Drawn	Symbol	CITILIGHT
						Name	CL-MU1WW1
						Drawing No	
Mark	Date	Description	Appro.	CITIZEN ELECTRONICS CO.,LTD.			

7. Taping Specifications (in accordance with JIS standard)

(1) Shape and Dimensions of Reel

(Unit: mm)

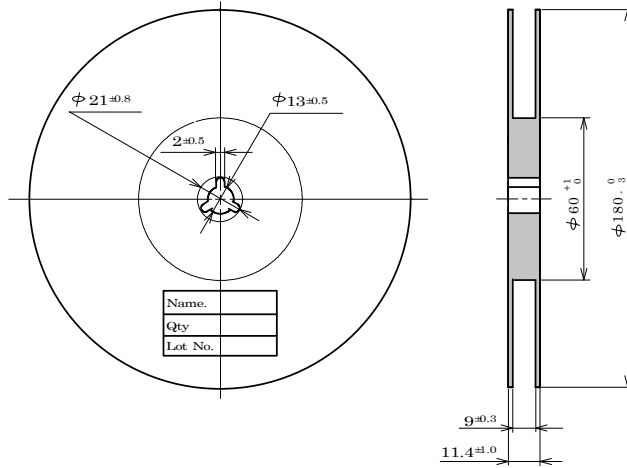

(2) Dimensions of Tape

(Unit: mm)

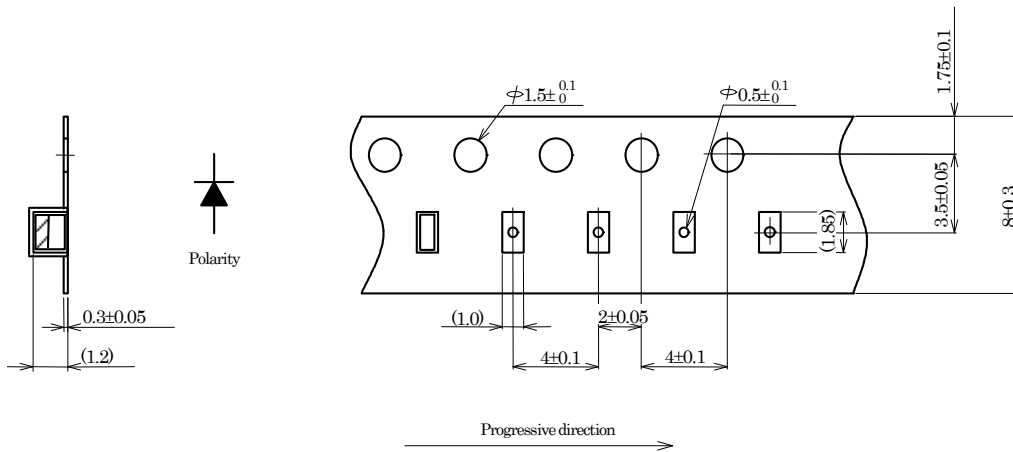

(3) Configuration of Tape

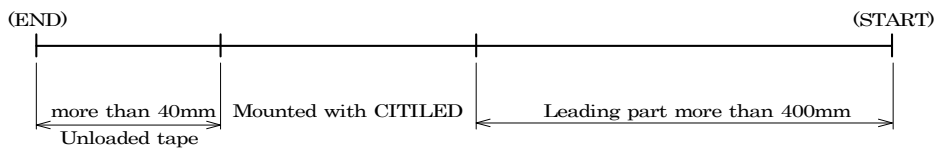

(4) Quantity: 2500pcs/reel

			Approved	Checked	Drawn	Symbol	CITILIGHT	
						Name	CL-MU1WW1	
						Drawing No		
Mark	Date	Description	Appr.					CITIZEN ELECTRONICS CO.,LTD.

8. Packing Specifications

8-1. Moisture-proof Packing

To prevent moisture absorption during transportation and storage, reels are packed in aluminum envelopes which contain a desiccant with a humidity indicator.

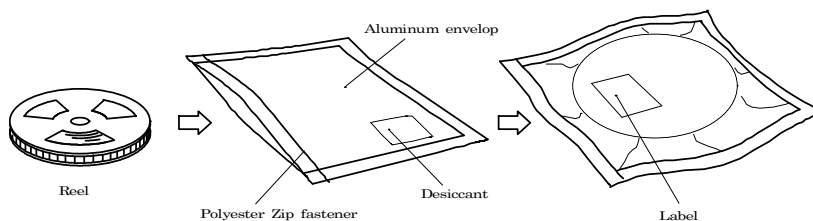

8-2. Storage

To prevent moisture absorption, it is strongly recommended that reels (in bulk or taped) should be stored in the dry box (or the desiccator) with a desiccant as the appropriate storage place. If not, the following is recommended.

Temperature: 5~30C  
 Humidity: 60%RH max

The devices should be mounted as soon as possible after unpacking. If you store the unpacked reels, please store them in the dry box or seal them into the envelop again.

			Approved	Checked	Drawn	Symbol	CITILIGHT
						Name	CL-MU1WW1
						Drawing No	
Mark	Date	Description	Appr.	CITIZEN ELECTRONICS CO.,LTD.			

# SPECIFICATIONS

10/11

## 9. Precautions

### 9-1. Soldering

#### (1) Lead free solderin

- 1) Following soldering paste is recommended  
 Melting temperature: 216 ~ 220C.  
 Composition: Sn 3.5Ag 0.75Cu
- 2) The temperature profile at the top surface of the parts is recommended as shown below.
- 3) It is requested that products should be handled after their temperature has dropped down to the normal room temperature

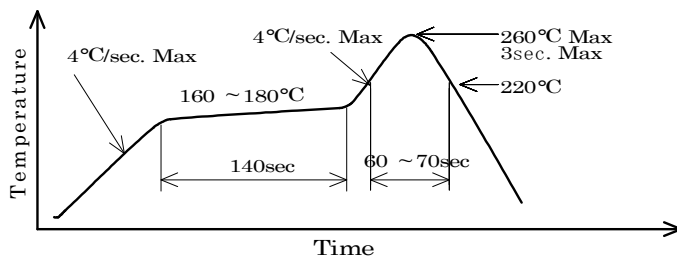

### 9-2. Washing

- (1) When washing after soldering is needed, following conditions are requested.
  - a) Washing solvent: Pure Water
  - b) Temperature, time: 50C or less × 30 seconds max.  
 or 30C or less × 3 minutes max.
  - c) Ultrasonic washing: 300W or less

### 9-3. Other directions

- (1) It is requested to avoid any stress added to the resin portion while it is heated.
- (2) It is requested to avoid any friction by sharp metal nail etc. to the resin portion.

			Approved	Checked	Drawn	Symbol	CITILIGHT
						Name	CL-MU1WW1
						Drawing No	
Mark	Date	Description	Appr.	CITIZEN ELECTRONICS CO.,LTD.			

10. Designing precautions

- (1) The current limiting resistor should be placed in the circuit so that is driven within its rating. Also avoid reverse voltage (over-current) applied instantaneously when ON or OFF.
- (2) When pulse driving current is applied, average current consumption should be within the rating. Also avoid reverse voltage applied when put off.
- (3) Recommended soldering pattern

<For reflow soldering>

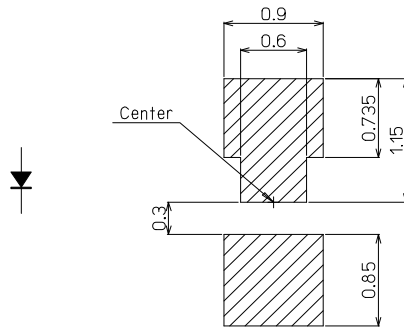

Unit : mm

The above dimensions are not the one which guarantee the performance of mountability. The use of the above pattern is recommended to use after deep study at your site.

- (4) When assembling the circuit board into the finished products, care must be taken to avoid the component parts from touching other parts.
- (5) When using multiple LEDs, it is required to connect a current limiting resistor on each path which the current flows to the LEDs.

(ex-1)

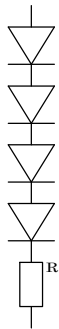

(ex-2)

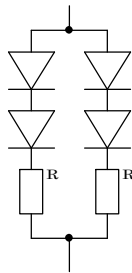

(ex-3)

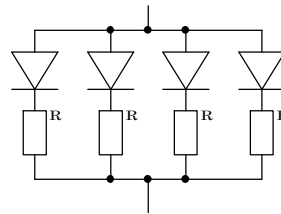

(6) Other

- 1) This product complies with RoHs directives.
- 2) When this product is secondarily fabricated such as change in shape, it is not included in our warranty.
- 3) The agreement of formal product specifications is required prior to mass production.

			Approved	Checked	Drawn	Symbol	CITILIGHT
						Name	CL-MU1WW1
						Drawing No	
Mark	Date	Description	Appro.	CITIZEN ELECTRONICS CO.,LTD.			