

Specification sheet

1/10

1. Scope of Application

These specifications apply to LED package, model CL-L102-C7WW.

2. Part code

CL-L102-C7WW

Series _____
 L102 : High power LED for general lighting

Watt Class _____
 C7 : 7 watt class package

Lighting color _____
 WW : White (CCT around 3500K)

Dec. 17, 2007			Approved	Checked	Drawn	Symbol	
						Name	CL-L102-C7WW
						Drawing No.	
Mark	Date	Description	CITIZEN ELECTRONICS CO.,LTD.				

3. Outline drawing

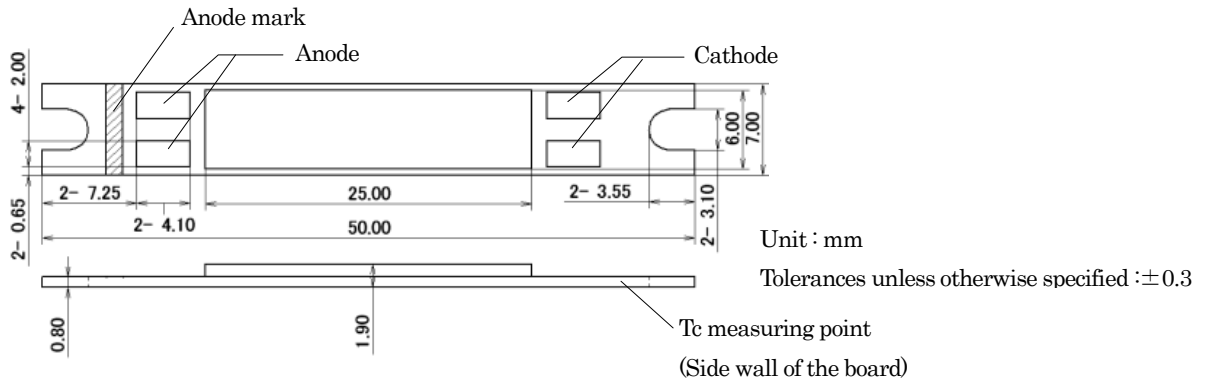

4. Performance

(1) Absolute Maximum Ratings

Parameter	Symbol	Rating Value	Unit
Power Dissipation	Pd	13.7	W
Forward Current	IF	1000	mA
Forward Pulse Current	IFP	1600	mA
Reverse Voltage	VR	15	V
Operating Temperature	TOP	-20~+85	°C
Storage Temperature	TST	-30~+100	°C
Junction Temperature	Tj	120	°C
Case Temperature	Tc	100	°C

*1
*2

*1 Duty≤1/10, Pulse Width≤10msec

*2 D.C. Drive : $T_j = T_c + R_{j-c} * P_d$

Pulse Drive : $T_j = T_c + R_{j-c} * P_w$ (Power Dissipation / one-Pulse) * Duty

(2) Electro - Optical Characteristics

(Tc=25°C)

Parameter	Symbol	Condition	Min	Typ.	Max.	Unit
Forward Voltage	VF	IF=700mA	9.0	11.0	12.6	V
Reverse Current	IR	VR=15V	-	-	100	μA
Total Luminous Flux	Φv	IF=700mA	346	440	-	lm

Thermal Resistance	Rj-c	Junction to Case	-	4.0	-	°C/W
--------------------	------	------------------	---	-----	---	------

Note) The tolerance of measurement at our tester is VF ±3%, φv ±10%

Dec. 17, 2007		Approved	Checked	Drawn	Symbol	
					Name	CL-L102-C7WW
					Drawing No.	
Mark	Date	Description	CITIZEN ELECTRONICS CO.,LTD.			

Specification sheet

3/10

Chromaticity Coordinate (IF=700mA, Tc=25°C)

Rank		x	y
WWR1	a	0.397	0.405
	b	0.404	0.427
	c	0.422	0.436
	d	0.413	0.412

Rank		x	y
WWR2	a	0.413	0.412
	b	0.422	0.436
	c	0.445	0.448
	d	0.433	0.421

Rank		x	y
WWR3	a	0.390	0.383
	b	0.397	0.405
	c	0.413	0.412
	d	0.405	0.390

Rank		x	y
WWR4	a	0.405	0.390
	b	0.413	0.412
	c	0.433	0.421
	d	0.423	0.399

Rank		x	y
WWR5	a	0.386	0.370
	b	0.390	0.383
	c	0.405	0.390
	d	0.400	0.377

Rank		x	y
WWR6	a	0.400	0.377
	b	0.405	0.390
	c	0.423	0.399
	d	0.417	0.386

Chromaticity coordinate is the area surrounded with a, b, c, d.
 Note) The tolerance of measurement at our tester is (x, y)±0.01.

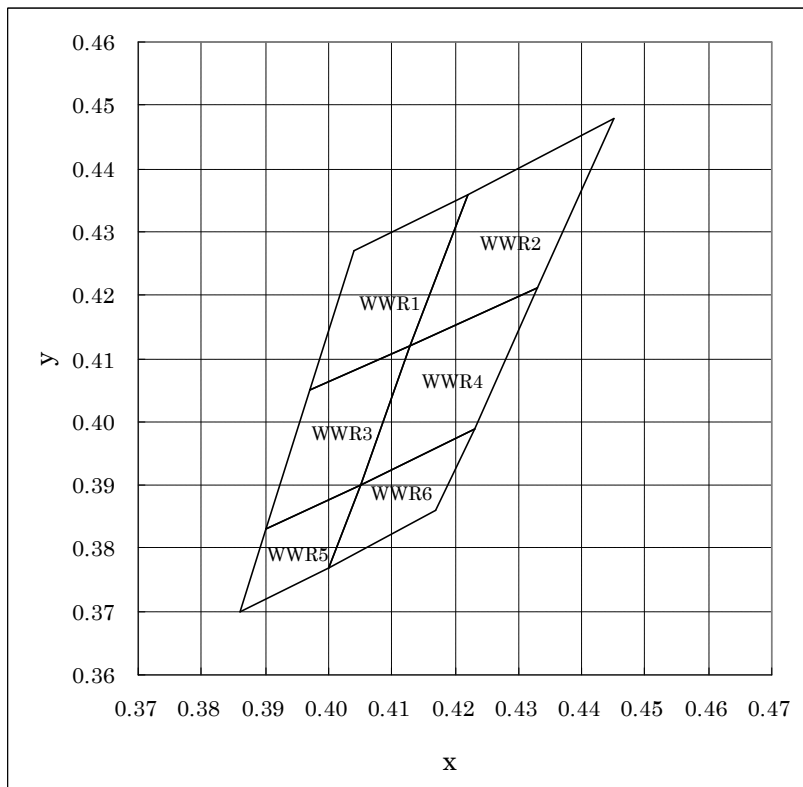

Dec. 17, 2007			Approved	Checked	Drawn	Symbol	
						Name	CL-L102-C7WW
						Drawing No.	
Mark	Date	Description	CITIZEN ELECTRONICS CO.,LTD.				

5. Characteristics

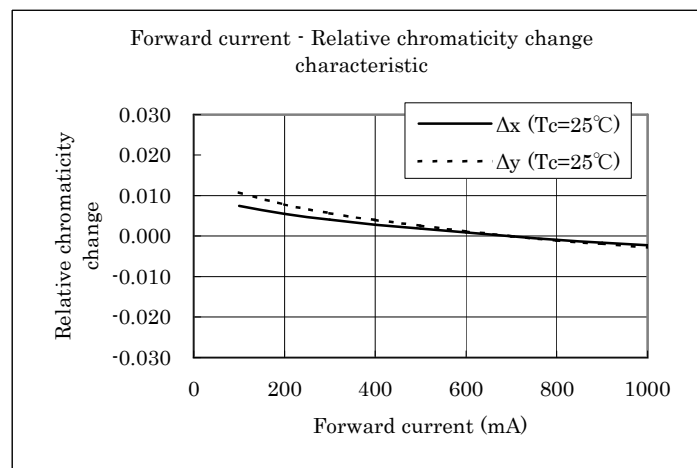
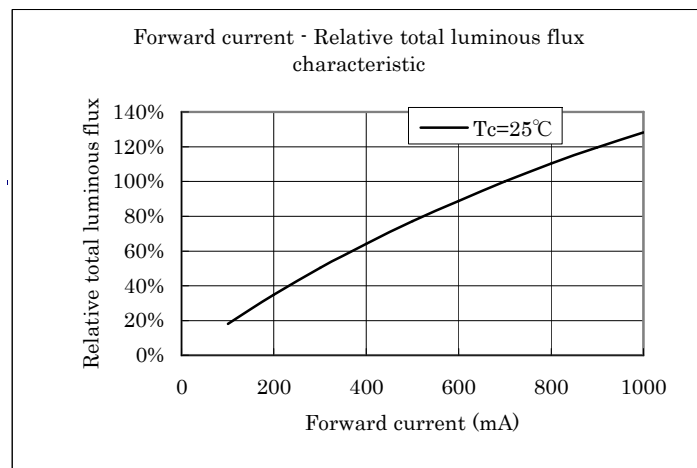
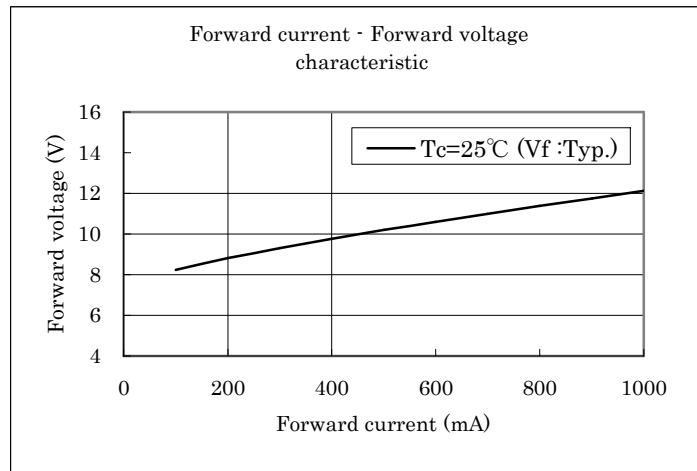

Dec. 17, 2007			Approved	Checked	Drawn	Symbol	
						Name	CL-L102-C7WW
						Drawing No.	
Mark	Date	Description	CITIZEN ELECTRONICS CO.,LTD.				

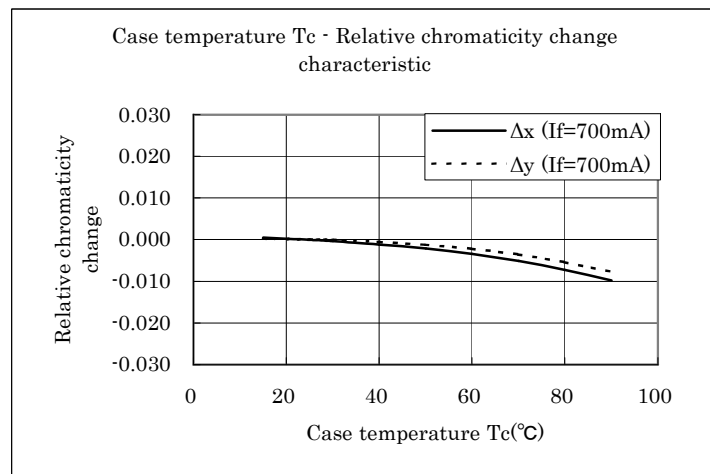
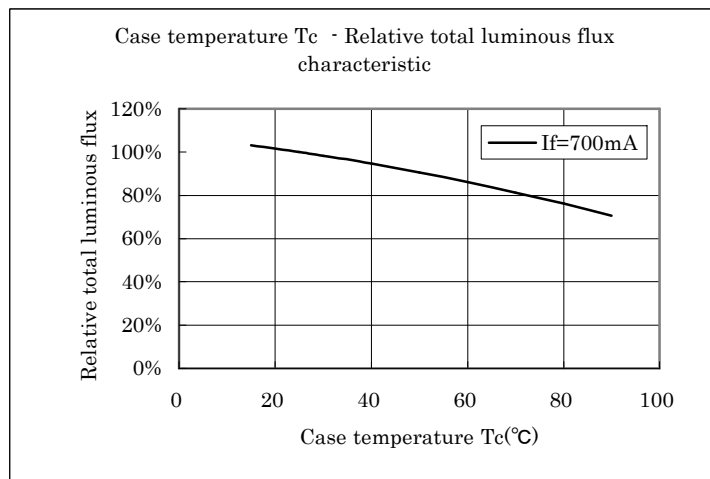
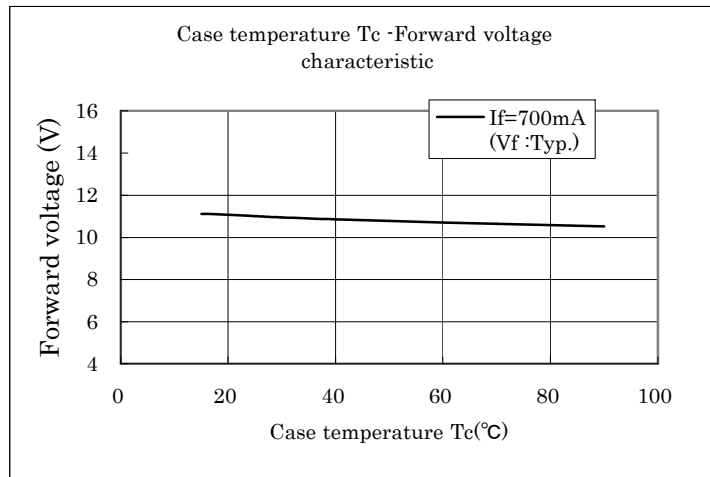

Dec. 17, 2007			Approved	Checked	Drawn	Symbol	
						Name	CL-L102-C7WW
						Drawing No.	
Mark	Date	Description				CITIZEN ELECTRONICS CO.,LTD.	

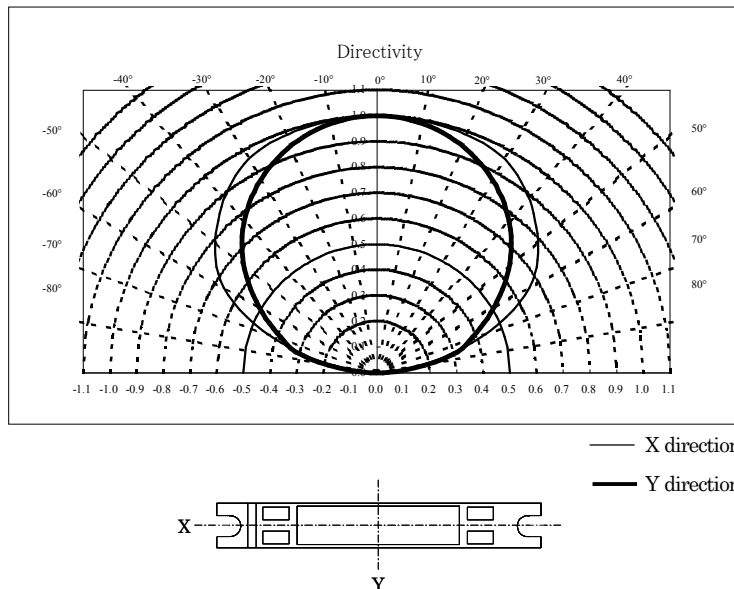
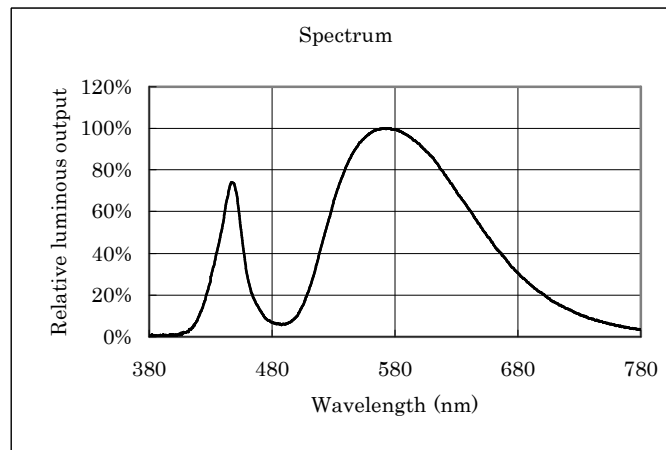
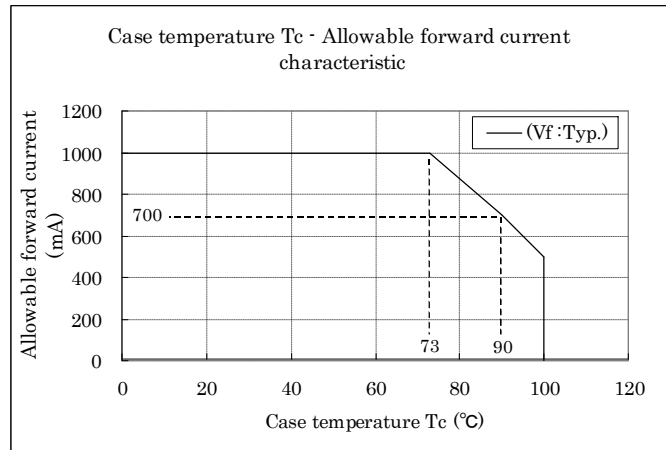

Dec. 17, 2007			Approved	Checked	Drawn	Symbol	
						Name	CL-L102-C7WW
						Drawing No.	
Mark	Date	Description	CITIZEN ELECTRONICS CO.,LTD				

6. Reliability

(1) Details of the tests

[Continuous operation test]

$I_F=700\text{mA}$, $T_a=-20^\circ\text{C}$ (with outer heat sink), 1000hours

$I_F=700\text{mA}$, $T_j=120^\circ\text{C}$ (with outer heat sink), 1000hours

$I_F=1000\text{mA}$, $T_j=120^\circ\text{C}$ (with outer heat sink), 1000hours

[High temperature storage test]

$T_a=100^\circ\text{C}$, 1000hours

[Low temperature storage test]

$T_a=-30^\circ\text{C}$, 1000hours

[Moisture-proof test]

$T_a=60^\circ\text{C}$, 90%RH, 1000hours

[Thermal Shock Test]

$T_a=-30^\circ\text{C}$ * 30 minutes - $T_a=85^\circ\text{C}$ * 30 minutes, 100-cycle

(2) Judgment criteria of failure for reliability test

($T_c=25^\circ\text{C}$)

Measuring Item	Symbol	Condition	Judgment Criteria for Failure
Forward voltage	V_F	$I_F=700\text{mA}$	$> U * 1.1$
Total Luminous flux	Φ_v	$I_F=700\text{mA}$	$< S * 0.7$

U means the upper limit of the specified characteristics.

S means the initial value.

Note) Measurement shall be taken between 2 hours and 24 hours, having returned the test pieces to the normal ambient conditions after the completion of each test.

Dec. 17, 2007			Approved	Checked	Drawn	Symbol				
						Name	CL-L102-C7WW			
						Drawing No.				
Mark	Date	Description				CITIZEN ELECTRONICS CO.,LTD.				

7. Packing specifications

(1) Primary packing

An empty tray is placed on top of a four-tier tray which contain 50 pieces each. The set of five trays is banded together by wrapping two rubber bands around it and then sealed in a plastic bag.

(Smallest packing unit: 200 pieces)

An indication label which specifies product name, quantity, lot number and shipment date is attached to the outside of the plastic bag.

- Tray (Dimensions: 310 × 200 × 11mm / Materials: Electrically conductive PS)

(2) Second packing

A set of five trays is placed in a box of up to five sets.

(Dimensions of box: 315mm × 215mm × 213mm, maximum of 1000 pieces per box)

The same indication label used for the primary packing is attached to the box. If needed, a card board box is also used for shipment.

< Tray dimensions >

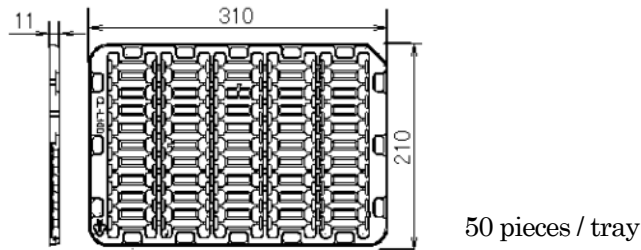

< Packing procedure >

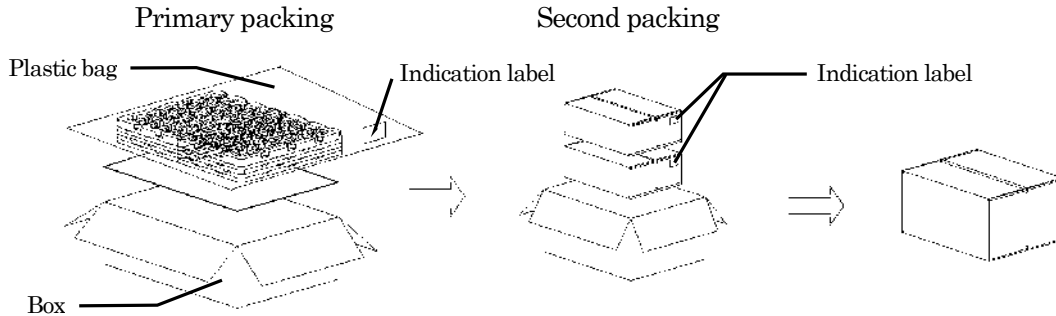

< Example of indication >



- 1. TYPE e.g. CL-L102-C7WW
- 2. P. NO. (Customer's P/N) e.g. XXX
- 3. Lot No. e.g. 73D001
 - First letter: Last digit of the year e.g. 7: year 2007
 - Second letter: Production month e.g. 3: March
 Note: October, November and December are designated by X, Y and Z, respectively.
- Third letter: CE's control number e.g. D001
- 4. Quantity e.g. 200 pieces

Dec. 17, 2007			Approved	Checked	Drawn	Symbol	
						Name	CL-L102-C7WW
						Drawing No.	
Mark	Date	Description	CITIZEN ELECTRONICS CO.,LTD.				

8. Precautions

- (1) Avoid the application of any stress to the lens portion.
- (2) Avoid any contact by a sharp metal nail or other materials with the lens portion.

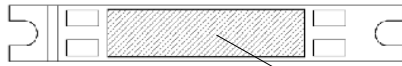

Lens portion (Shaded area)

- (3) This product should be secured firmly by fastening an M3 screw on both sides of the product. Please be careful not to apply any stress to the product during the clamping operation. As the connection status could vary depending on materials of outer heat sink, Please check thoroughly.

< Recommended installation screw pitch: 46.5 mm >

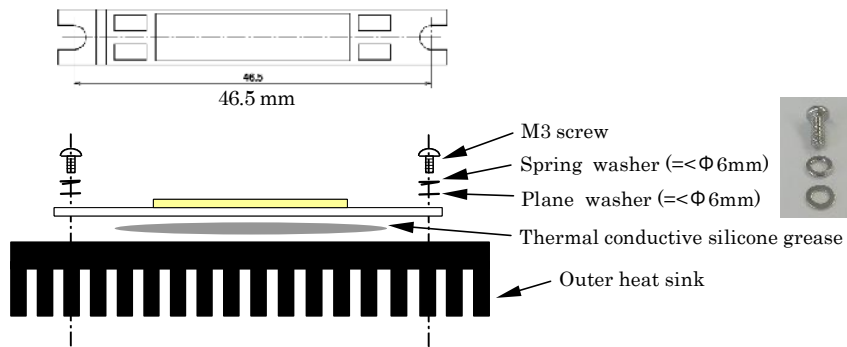

- (4) A heat radiating grease should be applied to the whole rear surface so that this product can dissipate heat as a whole. This product could be bent during the clamping operation if heat grease in sheet form is used. For this reason, it is recommended that grease in paste form is used.

(5) Handling of static electricity

- Please take measures to prevent any static electricity being produced such as the wearing of a wristband or anti-static gloves when handling this product.
- As for damages due to static electricity, please check them by lighting inspection.

CE's lighting inspection criterion

Condition	Judgmental criterion
IF =1mA or less	No-lighting should not exist

- (6) Please be aware that this product should not come into contact with any other parts in assembled status.

Dec. 17, 2007			Approved	Checked	Drawn	Symbol	
						Name	CL-L102-C7WW
						Drawing No.	
Mark	Date	Description				CITIZEN ELECTRONICS CO.,LTD.	

Specification sheet

10/10

Precautions (continued)

(7) Drive circuit

- A constant current circuit is recommended as a drive circuit.
And when two or more LED packages are connected, the series connection between each package is recommended.
- Please design a circuit that prevents any reverse voltage (excess current) from being applied to this product instantaneously when the circuit is ON or OFF.

(8) Heat generation

- As this product is designed in consideration of heat release property of module, a heat release design is required to use this product efficiently. Please ensure that heat generation is not in excess of absolute maximum rating. (Refer to 4.-(1) Performance)
- Factors responsible for an increase in temperature include heat generation attributed to ambient temperature conditions or power dissipation.
Thus, drive conditions should be taken into consideration, depending on ambient temperature (Ta).

(9) Recommended soldering

- Soldering operation should be performed within 3.5 seconds per land using a soldering iron of 40W or lower. The temperature of a soldering iron should be adjusted 350C or lower.
- No external force is applied to sealing resin during soldering operation.
- Please handle a product after it gets back to ordinary temperature.

Note: This product is not adaptable to reflow process.

(10) Other

- This product complies with RoHs directives.
- This product is intended for the application of general electronic devices (office automation equipment, communication devices, audio-video equipment, home electric appliances, measurement hardware and others). In cases where this product is used for the application that requires high reliability or could directly affect human life and body due to failure or malfunction (aerospace hardware, medical equipment, atomic control equipment and others), please consult with our sales representatives beforehand.
- When this product is secondarily fabricated such as change in shape, it is not included in our warranty.
- The agreement of formal product specifications is required prior to mass production.
- The specifications and appearance of this product are subject to change without advanced notice.

Dec. 17, 2007			Approved	Checked	Drawn	Symbol				
						Name	CL-L102-C7WW			
						Drawing No.				
Mark	Date	Description				CITIZEN ELECTRONICS CO.,LTD.				