

1. Scope of Application

These specifications are applied to the chip type LED lamp , model CL-L102-HC3L

2. Part code

CL - L102 - HC3L

Series

L102 : White power LED for general lighting.

Special specifications

H : High General Color Rendering Index Type.

Watt Class

C3 : 3 watt package.

Lighting color

L : White (CCT around 2900K)

			Approved	Checked	Drawn	Symbol	
			K.Fukasawa	K.Funakubo	T.Fuwa	Name	CL-L102-HC3L
						Drawing No	A96E-117-01
	2007.11.20	New implementation	Nov.20.'07	Nov.20.'07	Nov.20.'07		
Mark	Date	Description	Appro.	CITIZEN ELECTRONICS CO.,LTD.			

3. Outline drawing

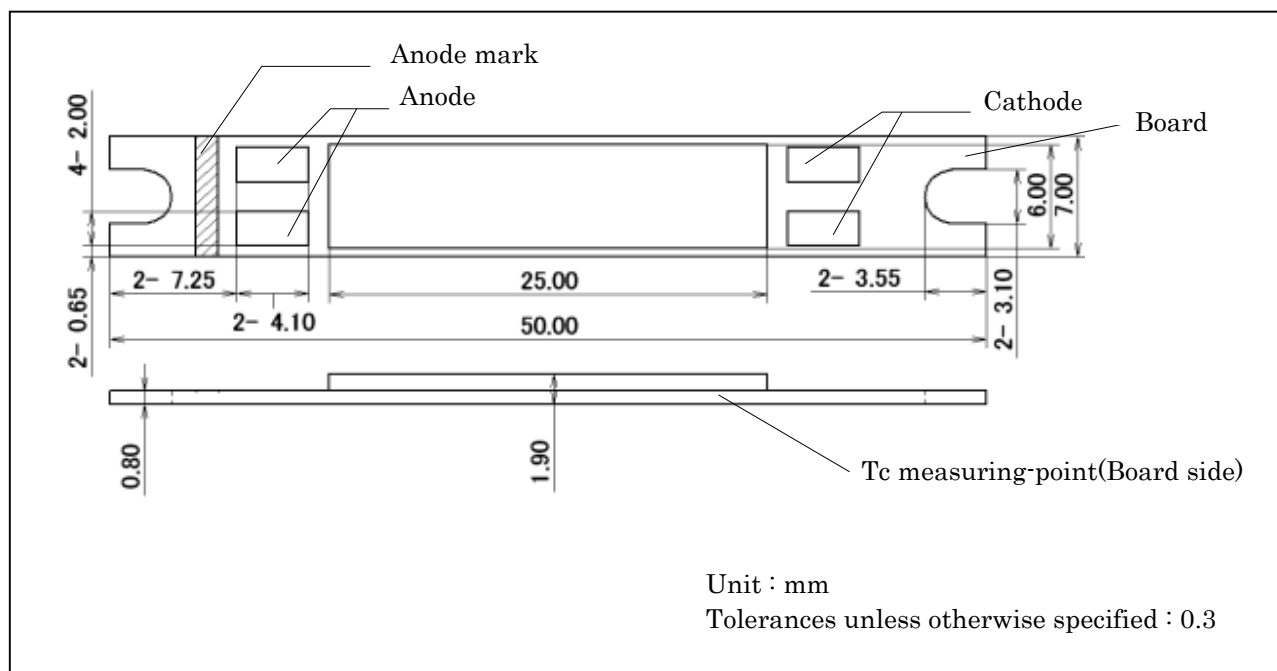

4. Performance

(1) Absolute Maximum Rating

Parameter	Symbol	Rating Value	Unit
Power Dissipation	P _d	6	W
Forward Current	I _F	500	mA
Forward Pulse Current	I _{FP}	800	mA
Reverse Voltage	V _R	15	V
Operating Temperature	T _{OP}	-20 ~ +85	°C
Storage Temperature	T _{ST}	-30 ~ +100	°C
Junction Temperature	T _{j Max}	120	°C

*1 Forward Current : Duty ≤ 1/10 , Pulse Width ≤ 10msec

*2 D.C. Current : $T_j = T_c + R_{j-c} * P_d$

Pulse Current : $T_j = T_c + R_{j-c} * P_w$ (Power Dissipation / one-Pulse) * duty

Mark	Date	Description	Appr.	Approved	Checked	Drawn	Symbol	Name	Drawing No
	2007.11.20	New implementation		K.Fukasawa	K.Funakubo	T.Fuwa		CL-L102-HC3L	A96E-217-01
				Nov.20.'07	Nov.20.'07	Nov.20.'07			
CITIZEN ELECTRONICS CO.,LTD.									

(2) Electro-optical Characteristics (Tc=25°C)

Parameter	Symbol	Condition	Min	Typ	Max	Unit
Forward Voltage	V_F	$I_F=350mA$	9.0	10.8	12.0	V
Reverse Current	I_R	$V_R=15V$	-	-	100	μA
Thermal resistance	R_{j-c}	Junction-case	-	6.0	-	$^{\circ}C/W$
Luminous Flux	Φ_v	$I_F=350mA$	119	160	-	lm
High General Color Rendering	Ra	$I_F=350mA$	-	95	-	-

Chromaticity coordinates (Condition : $I_F=350mA$, $T_c=25^{\circ}C$)

Color Rank	x	y	Color Rank	x	y
LR1	0.433	0.421	LR2	0.456	0.429
	0.445	0.448		0.470	0.457
	0.470	0.457		0.499	0.466
	0.456	0.429		0.481	0.435

Color Rank	x	y	Color Rank	x	y
LR3	0.417	0.386	LR4	0.437	0.392
	0.433	0.421		0.456	0.429
	0.456	0.429		0.481	0.435
	0.437	0.392		0.459	0.398

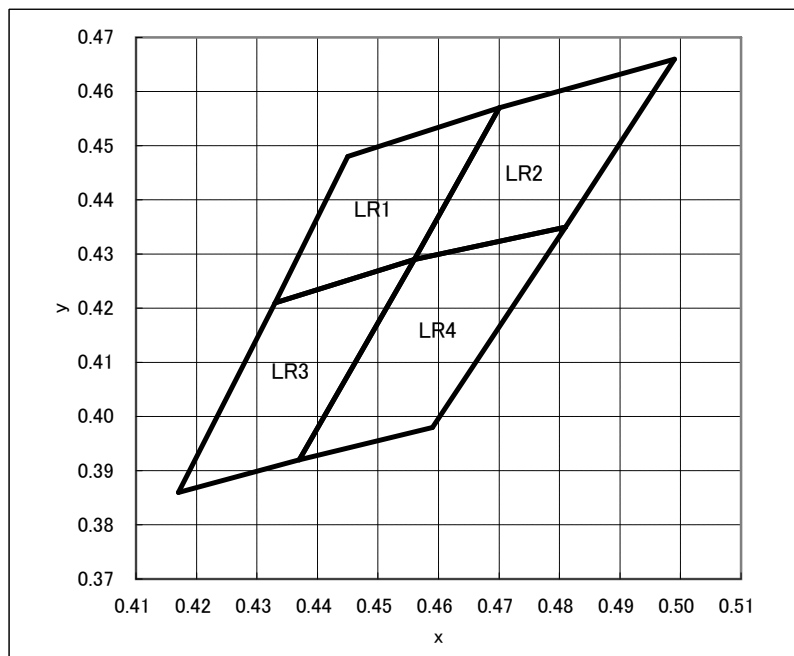

Note 1) The tolerance of measurement at our tester is $V_F \pm 3\%$, $\phi_v \pm 10\%$, Chromaticity(x,y) ± 0.01 .
 Note 2) For handling ,please apply CMOS LSI or equivalent any electrostatic effect.

			Approved	Checked	Drawn	Symbol	
			K.Fukasawa	K.Funakubo	T.Fuwa	Name	CL-L102-HC3L
			Nov.20.'07	Nov.20.'07	Nov.20.'07	Drawing No	A96E-317-01
Mark	Date	Description	Appro.	CITIZEN ELECTRONICS CO.,LTD.			

5. Characteristics

◆ Forward Current vs. Relative Luminous Flux ◆ Forward Current vs. Forward Voltage

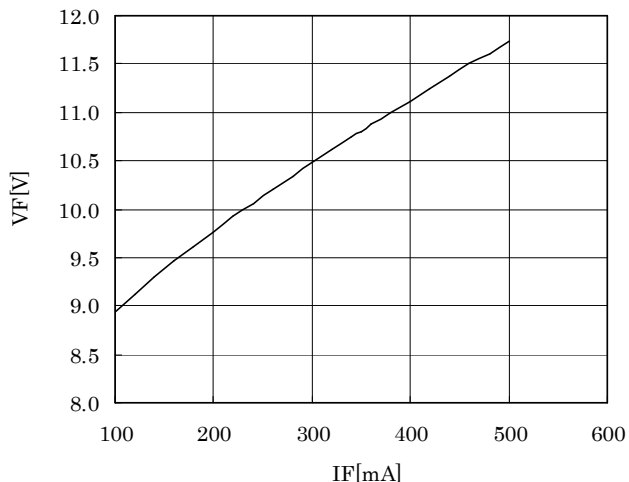
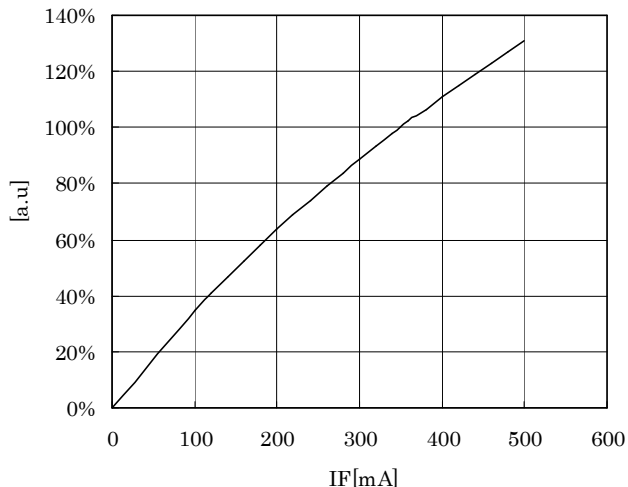

◆ Forward Current vs. Chromaticity Coordinate ◆ Case Temperature vs. Chromaticity Coordinate

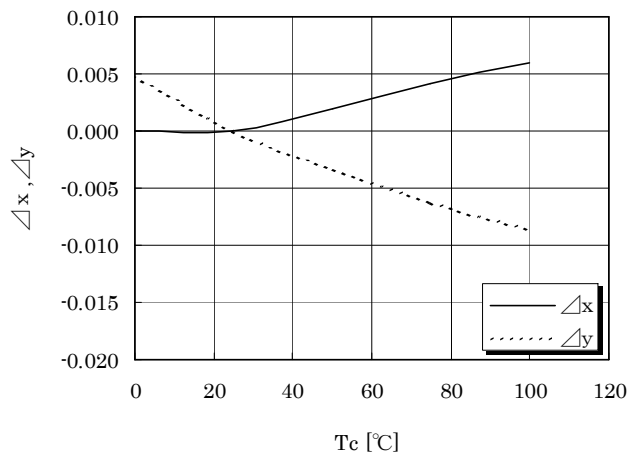
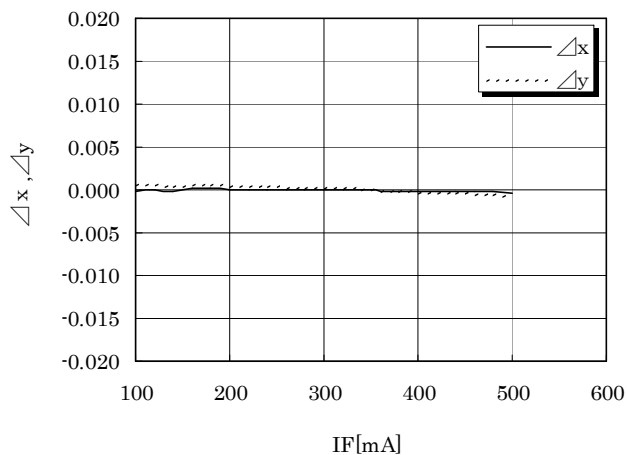

			Approved	Checked	Drawn	Symbol	
			K.Fukasawa	K.Funakubo	T.Fuwa	Name	CL-L102-HC3L
			Nov.20.'07	Nov.20.'07	Nov.20.'07	Drawing No	A96E-417-01
Mark	Date	Description	Appr.	CITIZEN ELECTRONICS CO.,LTD.			

◆ Case Temperature vs. Forward Voltage

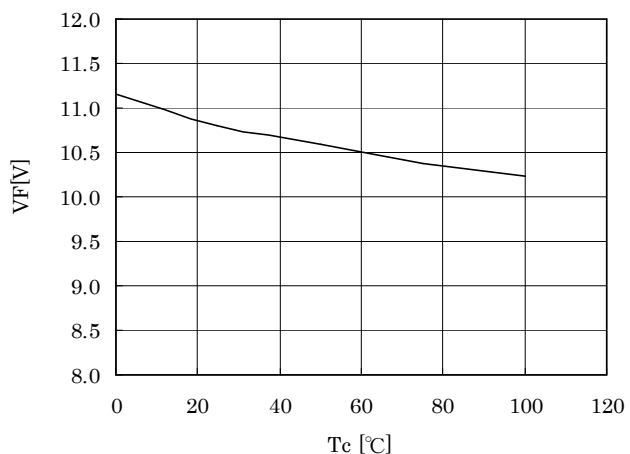

◆ Case Temperature vs. Relative Luminous Flux

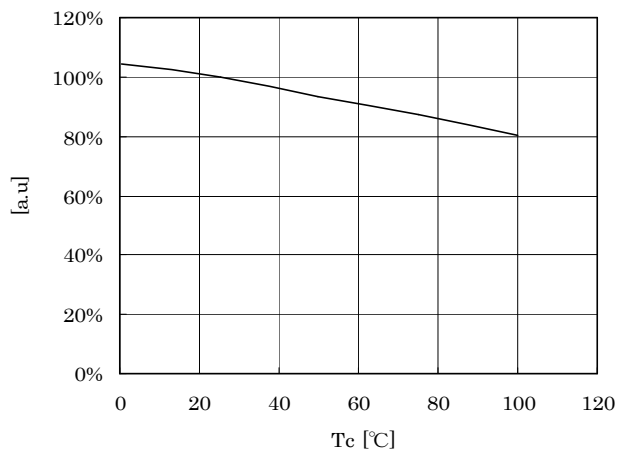

◆ Case Temperature vs. Allowable Forward Current

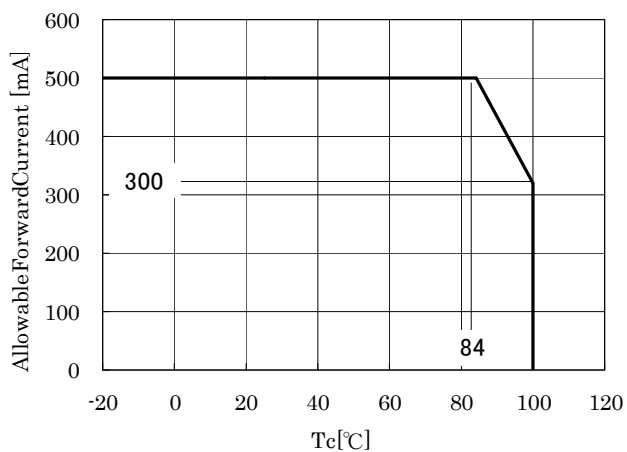

◆ Spectrum

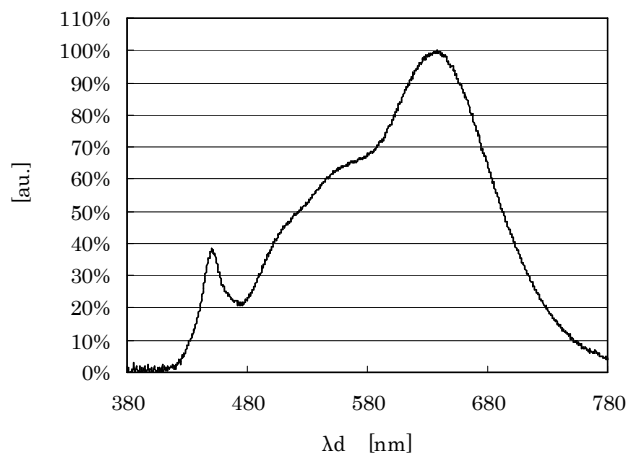

			Approved	Checked	Drawn	Symbol	
			K.Fukasawa	K.Funakubo	T.Fuwa	Name	CL-L102-HC3L
			Nov.20.'07	Nov.20.'07	Nov.20.'07	Drawing No	A96E-517-01
Mark	Date	Description	Appr.	CITIZEN ELECTRONICS CO.,LTD.			

6. Reliability

(1) Details of the tests

Test Item	Test Condition
Continuous Operation Test	Ta=-20°C, IF=350 mA (Tj=20°C)× 1000 hours(with Al-fin)
	Ta=60°C, IF=350 mA (Tj=100°C)×1000 hours(with Al-fin)
	Ta=80°C, IF=350 mA (Tj=120°C)×1000 hours(with Al-fin)
Low Temperature Storage Test	-30 °C × 1000 hours
High Temperature Storage Test	100 °C × 1000 hours
Moisture-proof Test	60 °C, 90 %RH for 1000 hours
Thermal Shock Test	-30°C × 30 minutes – 100°C × 30 minutes, 100- cycle

(2) Judgment Criteria of Failure for Reliability Test

(Tc=25°C)

Measuring Item	Symbol	Measuring Condition	Judgment Criteria for Failure
Forward Voltage	VF	IF=350mA	> U × 1.1
Total Luminous Flux	fV	IF=350mA	< S × 0.7

U defines the upper limit of the specified characteristics. S defines the initial value.

Note: Measurement shall be taken between 2 hours and 24 hours, and the test pieces should be returned to the normal ambient conditions after the completion of each test.

Mark	Date	Description	Appro.	Approved	Checked	Drawn	Symbol	
				K.Fukasawa	K.Funakubo	T.Fuwa	Name	CL-L102-HC3L
				Nov.20.'07	Nov.20.'07	Nov.20.'07	Drawing No	A96E-617-01
	2007.11.20	New implementation		Nov.20.'07	Nov.20.'07	Nov.20.'07		
CITIZEN ELECTRONICS CO.,LTD.								

7. Packing Specifications

(1) Primary packing

An empty tray is placed on top of a four-tier tray which contain 50 pieces each. The set of five trays is banded together by wrapping two rubber bands around it and then sealed in a plastic bag. (Smallest packing unit: 200 pieces)

An indication label which specifies product name, quantity, lot number and shipment date is attached to the outside of the plastic bag.

Tray (Dimensions: 310 × 200 × 11mm / Materials: Electrically conductive PS)

(2) Second packing

A set of five trays is placed in a box of up to five sets. (Dimensions of box: 315mm×215mm×213mm, maximum of 1000 pieces per box) The same indication label used for the primary packing is attached to the box. If needed, a card board box is also used for shipment.

< Packing figure >

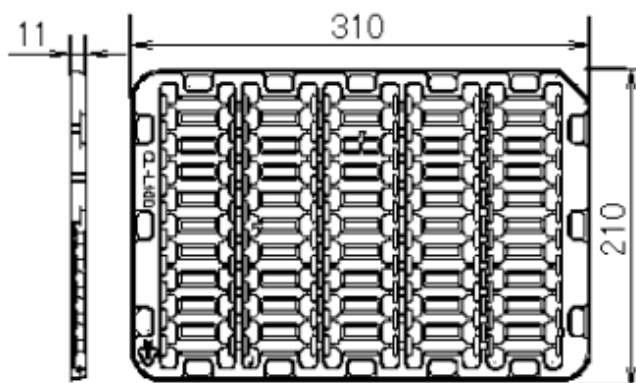

Product 50pcs/tray

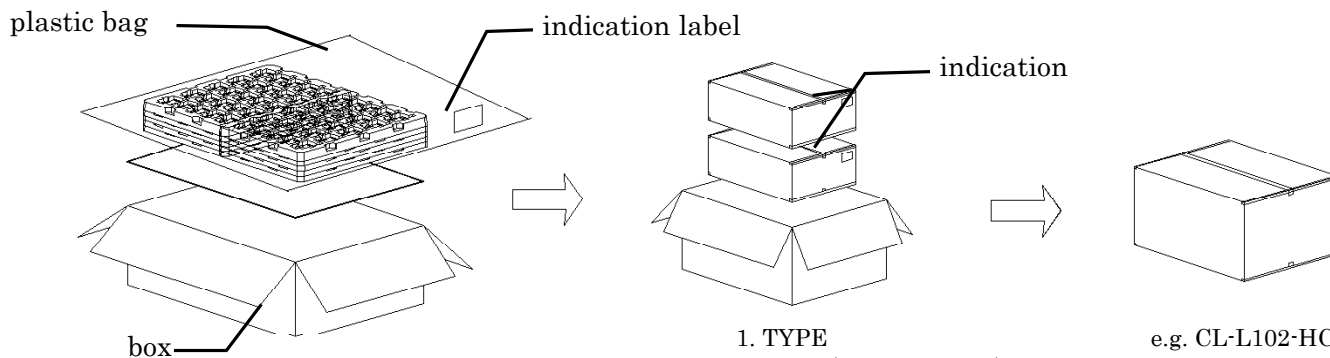

Example of indication

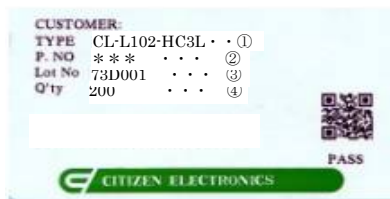

- 1. TYPE e.g. CL-L102-HC3L
- 2. P.No. (Cutomer's P/N) e.g. xxx
- 3. Lot No. e.g. 73D001
 - First letter: Last digit of the year e.g. 7→year 2007
 - Second letter: Production month e.g. 3→March
- Note: October, November and December are designated by X, Y and Z, respectively.
- Third letter: CE's control number e.g. D001
- 4. Quantity e.g. 200 pieces

			Approved	Checked	Drawn	Symbol	
			K.Fukasawa	K.Funakubo	T.Fuwa	Name	CL-L102-HC3L
						Drawing No	A96E-717-01
	2007.11.20	New implementation	Nov.20.'07	Nov.20.'07	Nov.20.'07		
Mark	Date	Description Appro.	CITIZEN ELECTRONICS CO.,LTD.				

Precautions

1. Avoid the application of any stress to the lens portion.
2. Avoid any contact by a sharp metal nail or other materials with the lens portion.

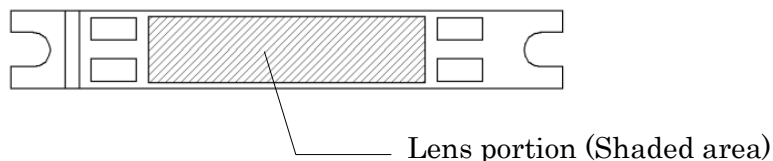

3. This product should be secured firmly by fastening an M3 screw on both sides of the product. Please be careful not to apply any stress to the product during the clamping operation. As the connection status could vary depending on materials of outer heat sink, please check thoroughly.

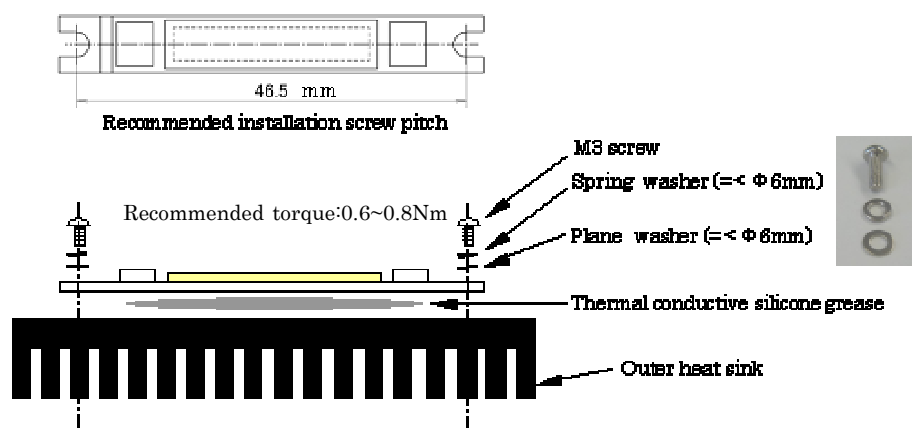

4. A heat radiating grease should be applied to the whole rear surface so that this product can dissipate heat as a whole. This product could be bent during the clamping operation if heat grease in sheet form is used. For this reason, it is recommended that grease in paste form is used.

5. Handling of static electricity

- Please take measures to prevent any static electricity being produced such as the wearing of a wristband or anti-static gloves when handling this product.
- As for damages due to static electricity, please check them by lighting inspection.

CE's lighting inspection criterion

Condition	Judgmental criterion
IF=1mA or less	No-lighting should not exist.

6. Please be aware that this product should not come into contact with any other parts in assembled status.

			Approved	Checked	Drawn	Symbol	
			K.Fukasawa	K.Funakubo	T.Fuwa	Name	CL-L102-HC3L
			Nov.20.'07	Nov.20.'07	Nov.20.'07	Drawing No	A96E-817-01
2007.11.20	New implementation	Nov.20.'07					
Mark	Date	Description	Appro.	CITIZEN ELECTRONICS CO.,LTD.			

Precautions (continued)

7. Drive circuit

- A constant current circuit is recommended as a drive circuit. And when two or more LED packages are connected, the series connection between each package is recommended.
- Please design a circuit that prevents any reverse voltage (excess current) from being applied to this product instantaneously when the circuit is ON or OFF.

8. Heat generation

- As this product is designed with consideration of the heat release property of module, a heat release design is required to use this product efficiently. Please ensure that heat generation is not in excess of the absolute maximum rating. (Refer to 4-1 Performance)
- Factors responsible for an increase in temperature include heat generation attributed to ambient temperature conditions or power dissipation. Thus, drive conditions should be taken into consideration, depending on ambient temperature (Ta).

9. Recommended soldering

- Soldering operation should be performed within 3.5 seconds per land using a soldering iron of 40W or lower. The temperature of a soldering iron should be adjusted 350C or lower.
- No external force is applied to sealing resin during soldering operation.
- Please do not handle a product until it returns to a normal temperature.

Note: This product is not adaptable to reflow process.

10. Other

- This product complies with RoHs directives.
- This product is intended for the application in general electronic devices (such as office automation equipment, communication devices, audio-video equipment, home electrical appliances, measurement hardware and others).
In cases where this product is used for the applications that requires high reliability or could directly affect human life or health due to failure or malfunction (aerospace hardware, medical equipment, atomic control equipment and others), please consult with our sales representatives beforehand.
- Our warranty does not cover situations where this product undergoes secondary fabrication such as changes in shape.
- An agreement of formal product specifications is required prior to mass production.
- The specifications and appearance of this product are subject to change without advanced notice.

			Approved	Checked	Drawn	Symbol	
			K.Fukasawa	K.Funakubo	T.Fuwa	Name	CL-L102-HC3L
						Drawing No	A96E-917-01
	2007.11.20	New implementation	Nov.20.'07	Nov.20.'07	Nov.20.'07		
Mark	Date	Description	Appro.	CITIZEN ELECTRONICS CO.,LTD.			