

SPECIFICATIONS OF CITED

1 / 10

1. Scope of Application

These specifications apply to chip type LED lamp, CITED, model CL-L270-2MU1L2-T.

2. Part code

C L - L 2 7 0 - 2 M U 1 L 2 - T

Series _____

270 : White LED for general lighting.

Quantity of dies _____

2 : 2Dies.

Special specifications _____

M : General Color Rendering Index Typ.85 type.

Watt Class _____

U1 : Under 1 watt package.

Lighting Color _____

L2: White color

Shipping mode _____

Non-coded : Bulk

T : Taping (standard)

			Approved	Checked	Drawn	Symbol	CITED
			Feb.03.'10	Feb.03.'10	Feb.03.'10	Name	CL-L270-2MU1L2
			K.Funakubo	K.Sasuga	T.Wada	Drawing No	
Mark	Date	Description Appr.	CITIZEN ELECTRONICS CO.,LTD.				

3. Outline drawing

Unit: mm
Tolerance: ±0.1

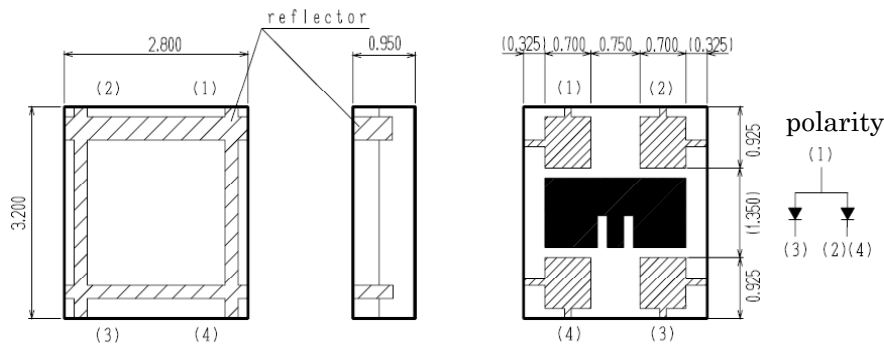

4. Performance

(1) Absolute Maximum Rating

Parameter	Symbol	Rating Value	Unit
Power Dissipation	P_d	296	mW
Forward Current	I_F	80	mA
Forward Pulse Current *	I_{FP}	100 *	mA
Reverse Voltage	V_R	5	V
Operating Temperature	T_{op}	-30 ~ +85	°C
Storage Temperature	T_{st}	-40 ~ +100	°C
Junction Temperature	T_{jMax}	120	°C

*Duty ≤ 1/10, Pulse width ≤ 0.1 sec

* $T_j = T_c + R_{j-s} \times P_d$ (D.C.driving) * T_c :Temperature of Solder terminal(4)

(2) Electro-optical Characteristic

($T_c = 25^\circ C$)

Parameter	Symbol	Condition	MIN	TYP	MAX	Unit
Forward Voltage	V_F	$I_F = 60mA$	3.1	3.35	3.7	V
Reverse Current	I_R	$V_R = 5V$	-	-	100	μA
Luminous Intensity *1	I_V	$I_F = 60mA$	4.73	6.45	8.06	cd
Thermal resistance	R_{j-s}	junction-solder	-	76	-	°C/W
Luminous Flux	ϕ_V	$I_F = 60mA$	-	(16.2)	-	lm
General Color Rendering Index	R_a *2	$I_F = 60mA$	80	85	-	-

*1In accordance with NIST standard The values are based on 2-dies performance

*2[CIE13.3-1995]

Mark	Date	Description	Approved	Checked	Drawn	Symbol	CITELED
			Feb.03.'10 K.Funakubo	Feb.03.'10 K.Sasuga	Feb.03.'10 T.Wada	Name	CL-L270-2MU1L2
						Drawing No	
			CITIZEN ELECTRONICS CO.,LTD.				

SPECIFICATIONS OF CITILED

3 / 10

Chromaticity coordinates (Condition : $I_F=60\text{mA}$, $T_C=25^\circ\text{C}$)

Color Rank	x	y
1	0.4562	0.4260
	0.4499	0.4138
	0.4579	0.4156
	0.4646	0.4280
2	0.4646	0.4280
	0.4579	0.4156
	0.4659	0.4175
	0.4729	0.4299
3	0.4729	0.4299
	0.4659	0.4175
	0.4740	0.4194
	0.4813	0.4319
4	0.4499	0.4138
	0.4436	0.4015
	0.4513	0.4033
	0.4579	0.4156
5	0.4579	0.4156
	0.4513	0.4033
	0.4590	0.4051
	0.4659	0.4175
6	0.4659	0.4175
	0.4590	0.4051
	0.4666	0.4069
	0.4740	0.4194

Color Rank	x	y
7	0.4436	0.4015
	0.4373	0.3893
	0.4446	0.3910
	0.4513	0.4033
8	0.4513	0.4033
	0.4446	0.3910
	0.4520	0.3927
	0.4590	0.4051
9	0.4590	0.4051
	0.4520	0.3927
	0.4593	0.3944
	0.4666	0.4069

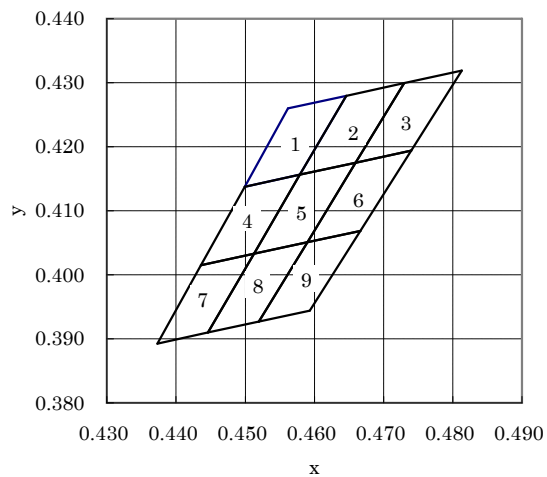

Ranking(Condition: $I_F=60\text{mA}$, $T_C=25^\circ\text{C}$)

Parameter	Symbol	Rank	Min	Max	Unit
Forward Voltage	V_F	Q	3.10	3.30	V
		R	3.30	3.50	
		S	3.50	3.70	
Luminous Intensity	I_V	B	4.73	5.96	cd
		C	5.96	6.93	
		D	6.93	8.06	

Note 1) The tolerance of forward voltage(V_F) measurement is $V_F \pm 3\%$ at our tester

Note 2) The tolerance of luminous Intensity(I_V) measurement is $\pm 10\%$ at our tester

Note 3) The tolerance of Chromaticity coordinates (x,y)measurement is ± 0.01 at our tester

Measurement Conditions

- 1) Chip is mounted on board(size 100mm×40mm)
- 2) Board material is FR-4, covered with green color resist and thickness of copper is 18 μm .

Mark	Date	Description	Appro.	Approved	Checked	Drawn	Symbol	CITILED
				Feb.03.'10	Feb.03.'10	Feb.03.'10	Name	CL-L270-2MU1L2
				K.Funakubo	K.Sasuga	T.Wada	Drawing No	

5. Characteristic

I_F - I_V Characteristic $T_C=25^\circ\text{C}$

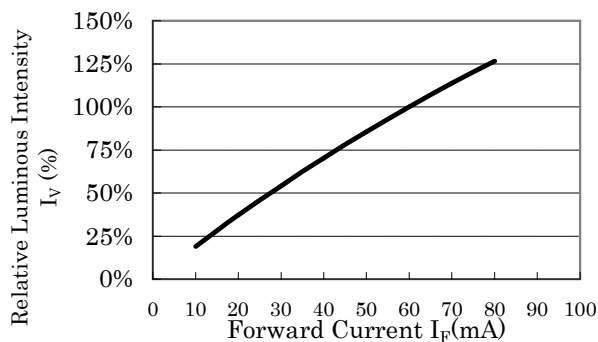

I_F - V_F Characteristic $T_C=25^\circ\text{C}$

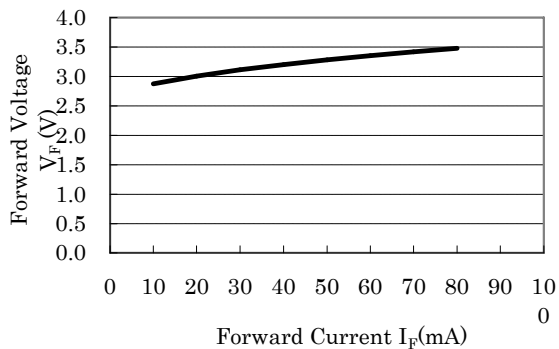

T_C - I_V Characteristic $I_F=60\text{mA}$

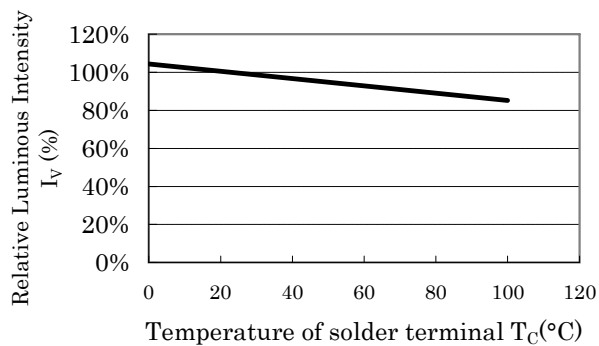

T_C - V_F Characteristic $I_F=60\text{mA}$

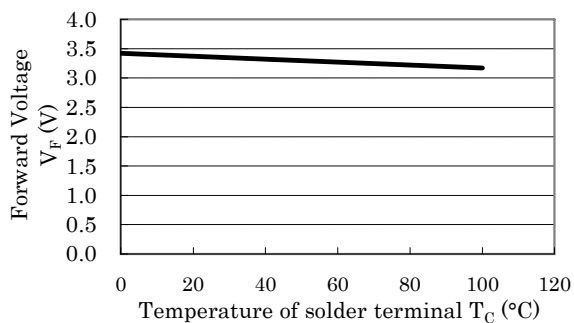

T_C - I_{Fmax} Characteristics

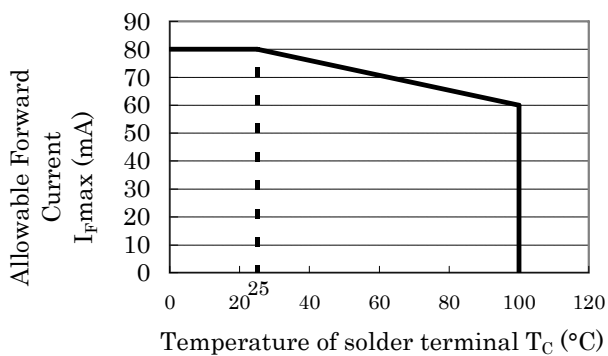

<Condition>
 Chip on board
 board size:100mm*40mm
 Materials:FR-4
 Thickness of Copper:18um

			Approved	Checked	Drawn	Symbol	CITELED
			Feb.03.'10	Feb.03.'10	Feb.03.'10	Name	CL-L270-2MU1L2
			K.Funakubo	K.Sasuga	T.Wada	Drawing No	
Mark	Date	Description	CITIZEN ELECTRONICS CO.,LTD.				

5. Characteristic

I_F - $\Delta x \Delta y$ Characteristic $T_C = 25^\circ C$

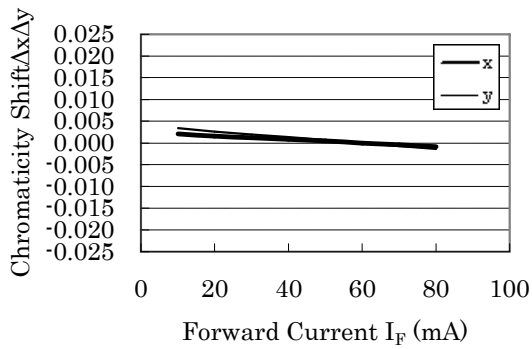

T_C - $\Delta x \Delta y$ Characteristic $I_F = 60mA$

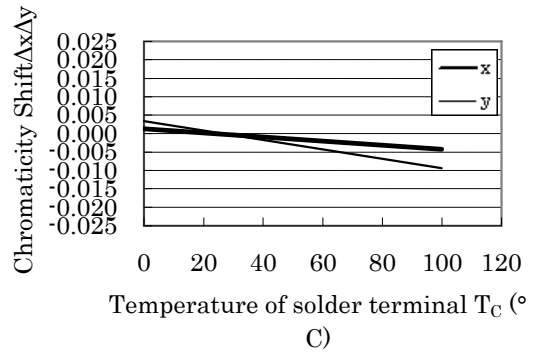

Directive Characteristic

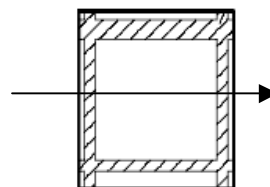
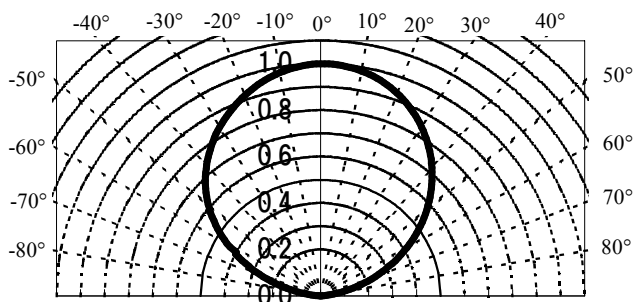
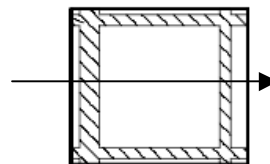
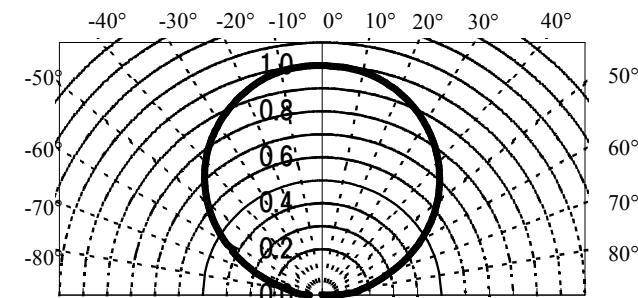

			Approved	Checked	Drawn	Symbol	CITILED
			Feb.03.'10	Feb.03.'10	Feb.03.'10	Name	CL-L270-2MU1L2
			K.Funakubo	K.Sasuga	T.Wada	Drawing No	
Mark	Date	Description	APPRO. CITIZEN ELECTRONICS CO.,LTD.				

SPECIFICATIONS OF CITELED

6 / 10

6. Reliability

(1) Details of the tests

Test Item	Test Condition
Life Test in Continuous Operation	25±3°C, I _F =60 mA × 1000+24/-12hours
Low Temperature Storage Test	-40+3/-5°C × 1000+24/-12hours
High Temperature Storage Test	100+5/-3°C × 1000+24/-12hours
Moisture-proof Test	60 ±2°C, 90 ±5%RH for 1000+24/-12hours
Thermal Shock Test	-40°C × 30 minutes and 100°C × 30 minutes, 100cycle
Solder Heat Resistance Test	Recommended temperature profile (reflow soldering)×2, (2nd test must be started after the samples are stabilized thermally.)

(2) Judgment Criteria of Failure for Reliability Test

Measuring Item	Symbol	Measuring Conditon	Judgement Criteria for Failure
Forward Voltage	V _F	I _F =60mA	> U×1.2
Reverse Current	I _R	V _F =5V	> U×2
Luminous Intensity	I _V	I _F =60mA	< S×0.7

U means the upper limit of the specified characteristics. S means the initial value.

Note: Measurement shall be taken between 2 hours and 24 hours, having returned the test pieces to the normal ambient conditions after the completion of each test.

Mark	Date	Description Appr.	Approved	Checked	Drawn	Symbol	CITELED
			Feb.03.'10 K.Funakubo	Feb.03.'10 K.Sasuga	Feb.03.'10 T.Wada	Name	CL-L270-2MU1L2
						Drawing No	

7. Taping Specifications (in accordance with JIS standard)

(1) Shape and Dimensions of Reel

(Unit: mm)

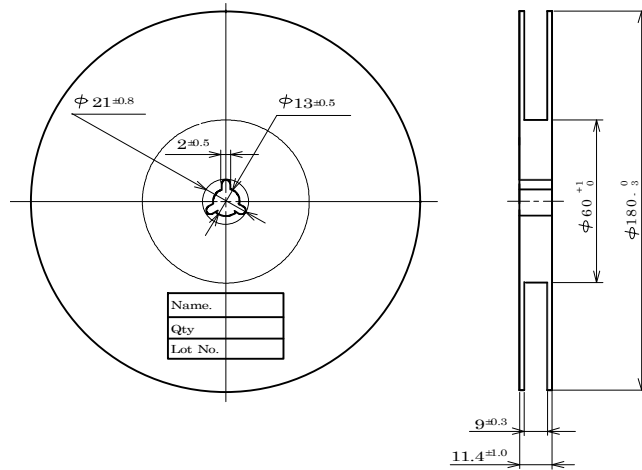

(2) Dimensions of Tape

(Unit: mm)

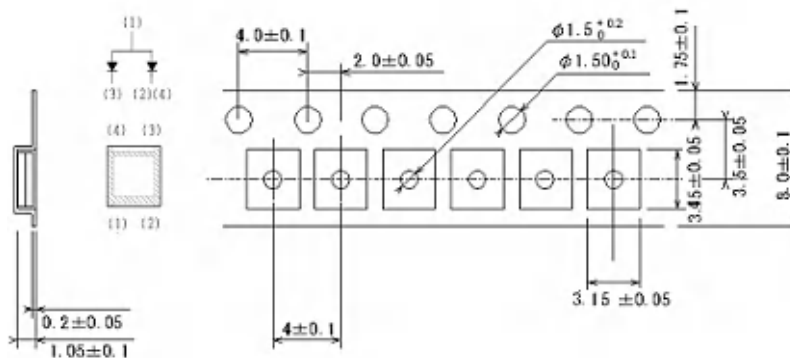

(3) Configuration of Tape

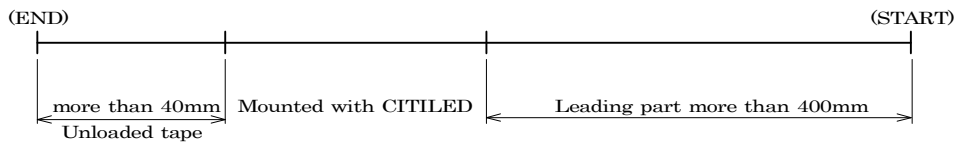

(4) Quantity: 3000pcs/reel

			Approved	Checked	Drawn	Symbol	CITILED
			Feb.03.'10	Feb.03.'10	Feb.03.'10	Name	CL-L270-2MU1L2
			K.Funakubo	K.Sasuga	T.Wada	Drawing No	
Mark	Date	Description	Appr.	CITIZEN ELECTRONICS CO.,LTD.			

8. Packing Specifications

8-1. Moisture-proof Packing

To prevent moisture absorption during transportation and storage, reels are packed in aluminum envelopes which contain a desiccant with a humidity indicator.

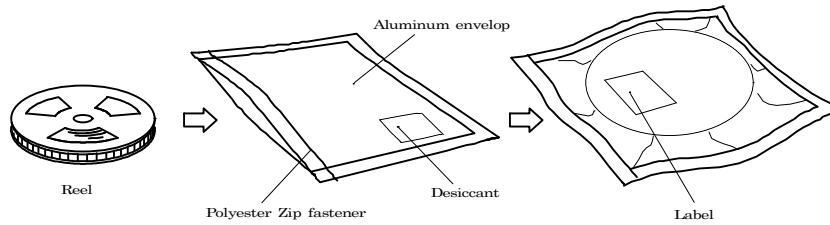

8-2. Storage

To prevent moisture absorption, it is strongly recommended that reels (in bulk or taped) should be stored in the dry box (or the desiccator) with a desiccant as the appropriate storage place. If not, the following is recommended.

Temperature: 5 ~ 30 °C
 Humidity: 60%RH max

The devices should be mounted as soon as possible after unpacking. If you store the unpacked reels, please store them in the dry box or seal them into the envelop again.

Moisture Sensitive Level1 (IPC/JEDEC J-STD-020C)

			Approved	Checked	Drawn	Symbol	CITELED
			Feb.03.'10	Feb.03.'10	Feb.03.'10	Name	CL-L270-2MU1L2
			K.Funakubo	K.Sasuga	T.Wada	Drawing No	
Mark	Date	Description Appro.	CITIZEN ELECTRONICS CO.,LTD.				

9. Precautions

9-1. Soldering

(1) Lead free soldering

1) Following soldering paste is recommended

Melting temperature: 216 ~ 220°C.

Composition: Sn 3.5Ag 0.75Cu

2) The temperature profile at the top surface of the parts is recommended as shown below.

3) It is requested that products should be handled after their temperature has dropped down to the normal room temperature

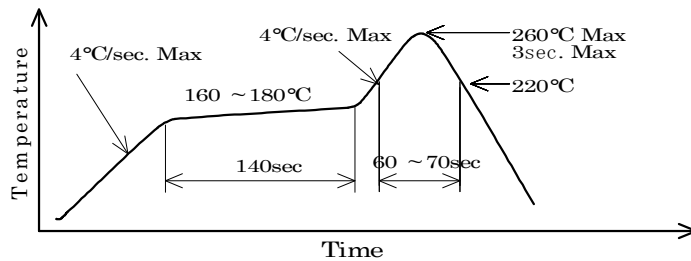

9-2. Washing

(1) When washing after soldering is needed, following conditions are requested.

a) Washing solvent: Pure Water

b) Temperature, time: 50°C or less × 30 seconds max.
or 30°C or less × 3 minutes max.

c) Ultrasonic washing: 300W or less

9-3. Other directions

(1) It is requested to avoid any stress added to the resin portion while it is heated.

(2) It is requested to avoid any friction by sharp metal nail etc. to the resin portion.

			Approved	Checked	Drawn	Symbol	CITELED
			Feb.03.'10	Feb.03.'10	Feb.03.'10	Name	CL-L270-2MU1L2
			K.Funakubo	K.Sasuga	T.Wada	Drawing No	
Mark	Date	Description	Appro. CITIZEN ELECTRONICS CO.,LTD.				

10. Designing precautions

- (1) The current limiting resistor should be placed in the circuit so that is driven within its rating. Also avoid reverse voltage (over-current) applied instantaneously when ON or OFF.
- (2) When pulse driving current is applied, average current consumption should be within the rating. Also avoid reverse voltage applied when put off.
- (3) Recommended soldering pattern

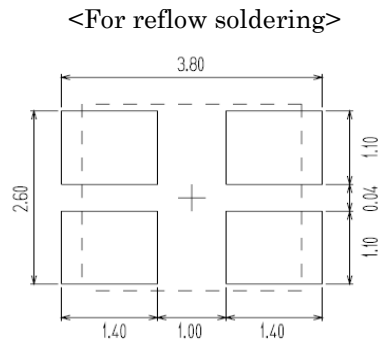

Unit : mm

The above dimensions are not the one which guarantee the performance of mountability. The use of the above pattern is recommended to use after deep study at your site.

- (4) When assembling the circuit board into the finished products, care must be taken to avoid the component parts from touching other parts.
- (5) When using multiple LEDs, it is required to connect a current limiting resistor on each path which the current flows to the LEDs.

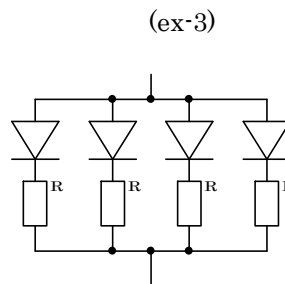
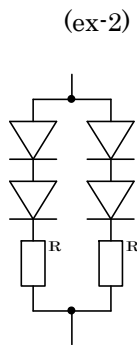
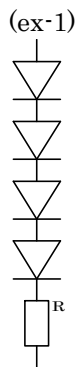

(6) Other

- 1) This product complies with RoHS directives.
- 2) When this product is secondarily fabricated such as change in shape, it is not included in our warranty.
- 3) The agreement of formal product specifications is required prior to mass production.

			Approved	Checked	Drawn	Symbol	CITILED
			Feb.03.'10	Feb.03.'10	Feb.03.'10	Name	CL-L270-2MU1L2
			K.Funakubo	K.Sasuga	T.Wada	Drawing No	
Mark	Date	Description Appro.	CITIZEN ELECTRONICS CO.,LTD.				