

SPECIFICATION FOR COTCO LED LAMP

Document No: SPE/ LP6-PPP1-01-N1
Model No : LP6-PPP1-01-N1
Rev. No : 02
Date: 2007-03-22

Description:

120 Degree 6.0 x 5.0mm SMT-LED in Full Color with Water Transparent

Dice Material: AlGaInP&InGaN

Confirmed
By Customer: _____

Date: _____

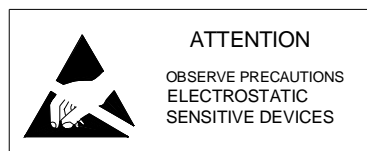

Document No.	SPE/LP6-PPP1-01-N1
Rev. No.	02

Applications:

- Indoor and outdoor displays
- Backlighting
- Camera Flash
- RGB full color displays

Absolute Maximum Ratings at Ta = 25°C

Items	Symbol	Absolute maximum Rating			Unit
		R	G	B	
Forward Current ^{*1}	I _F	80	80	80	mA
Peak Forward Current ^{*2}	I _{FP}	200	100	100	mA
Reverse Voltage	V _R	5	5	5	V
Power Dissipation	P _D	240	410	410	mW
Operation Temperature	T _{opr}	-40 ~ + 100			°C
Storage Temperature	T _{stg}	-40 ~ + 100			°C
Junction Temperature	T _j	110	110	110	°C
Junction/ambient 1 chips on ^{*3}	R _{th JA}	250	210	210	°C/W
Junction/ambient 3 chips on ^{*3}	R _{th JA}	500	300	300	°C/W
Junction/solder point 1 chips on	R _{th JS}	150	130	130	°C/W
Junction/solder point 3 chips on	R _{th JS}	150	160	160	°C/W

Dimension Drawing

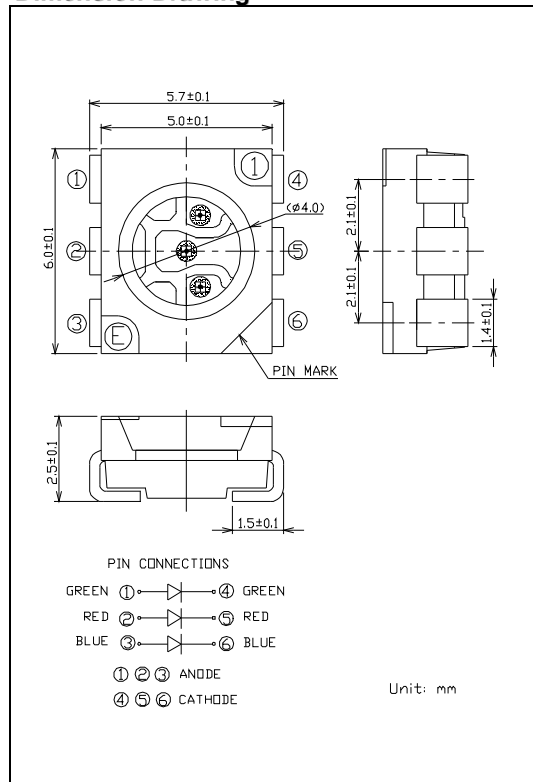

^{*1} single color light ^{*2} pulse width ≤ 0.1msec duty ≤ 1/10 ^{*3} R_{th} test condition: Mounted on PC Board FR 4 (pad size ≥ 40mm²)

Typical Electrical & Optical Characteristics(Ta = 25°C)

Parameter	Condition	Symbol	Values			Unit
			R	G	B	
Wavelength at peak emission	I _F =50mA	λ _{peak}	620	521	468	nm
Dominant wavelength	I _F =50mA	λ _{dom}	610-625	514-534	460~480	nm
Spectral bandwidth at 50% I _{rel} max	I _F =50mA	Δλ	24	38	28	nm
Viewing angle at 50% I _V	I _F =50mA	2 θ _½	120	120	120	Deg.
Forward voltage	I _F =50mA	V _{F(avg)}	2.0	4.0	4.0	V
		V _{F(max)}	2.5	5.1	5.1	V
Luminous Intensity	I _F =50mA	I _{V(Min)}	710	710	280	mcd
		I _{V(Avg)}	1000	900	390	mcd
Reverse current (max.)	V _R =5V	I _R	10	10	10	μA

Document No.	SPE/LP6-PPP1-01-N1
Rev. No.	02

Standard bins for LP6-PPP1-01-N1 (I_F =50mA):

Lamps are sorted to Luminous Intensity –I_V & Dominant Wavelength – λ_D bins shown.

Orders for LP6-PPP1-01-N1 may be filled with any or all bins contained as below.

All Luminous Intensity –I_V & Dominant Wavelength – λ_D values shown and specified are at If=50mA.

R * V+

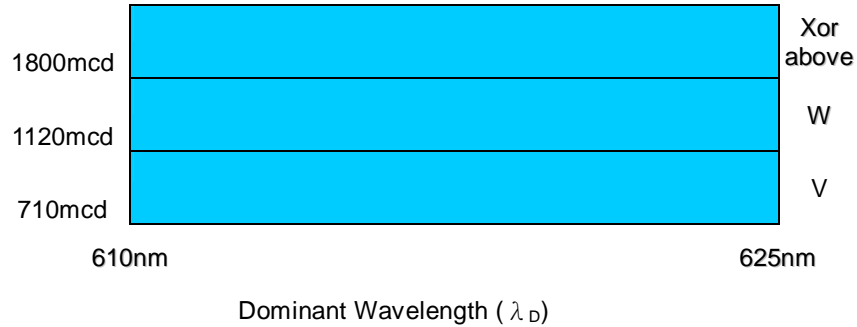

I V+ indicates Luminous Intensity of Red Rank is at V bin or above.

G * V+

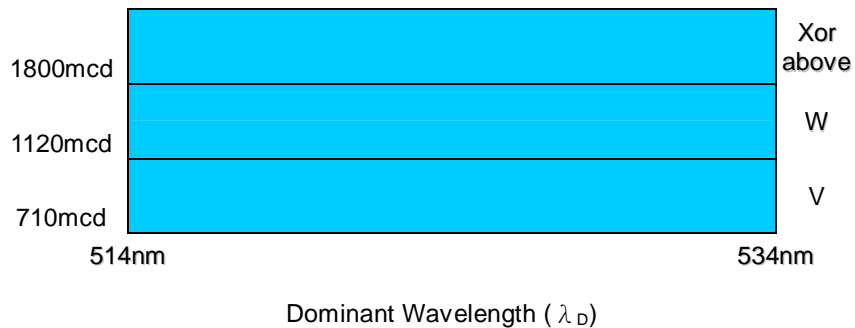

I V+ indicates Luminous Intensity of Green Rank is at V bin or above.

B * T±

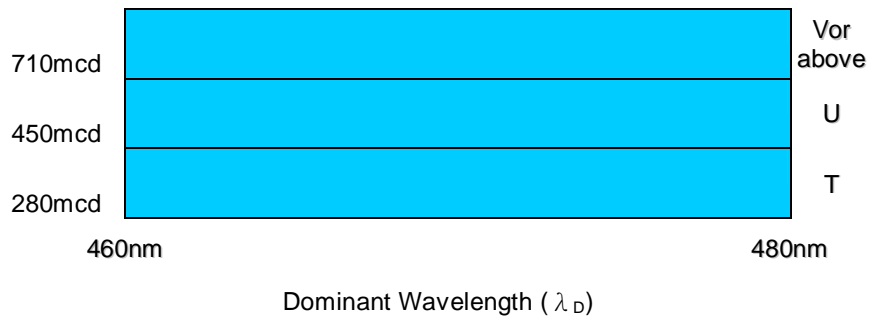

I T+ indicates Luminous Intensity of Blue Rank is at T bin or above.

Important Notes:

- 1) All ranks will be included per delivery, rank ratio will be based on Dices distribution.
- 2) Tolerance of measurement of luminous intensity is ±10%
- 3) Tolerance of measurement of dominant wavelength is ±1nm.
- 4) Tolerance of measurement of Vf is ±0.05 V.
- 5) Packaging methods are available for selection, please refer to PACKAGING STANDARD.
- 6) Please refer to LED LAMP RELIABILITY TEST STANDARD for reliability test conditions.
- 7) Please refer to APPLICATION NOTES for Application.

Document No.	SPE/LP6-PPP1-01-N1
Rev. No.	02

Graphs

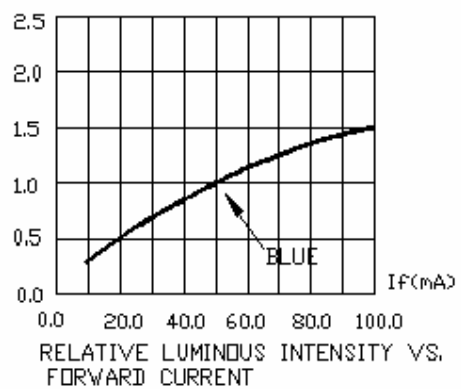
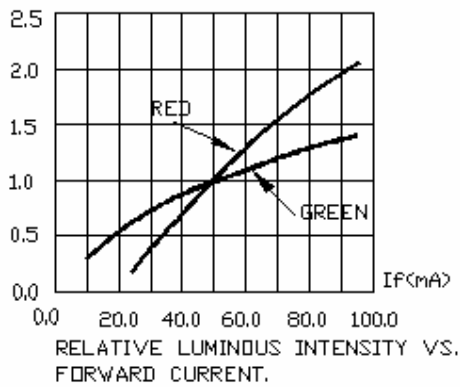
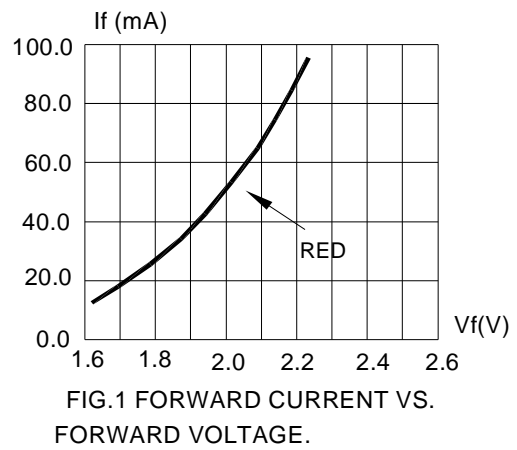
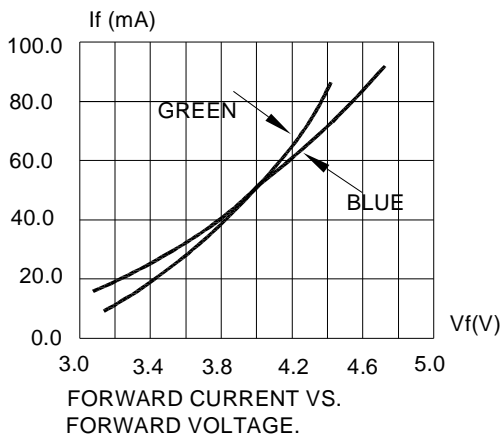
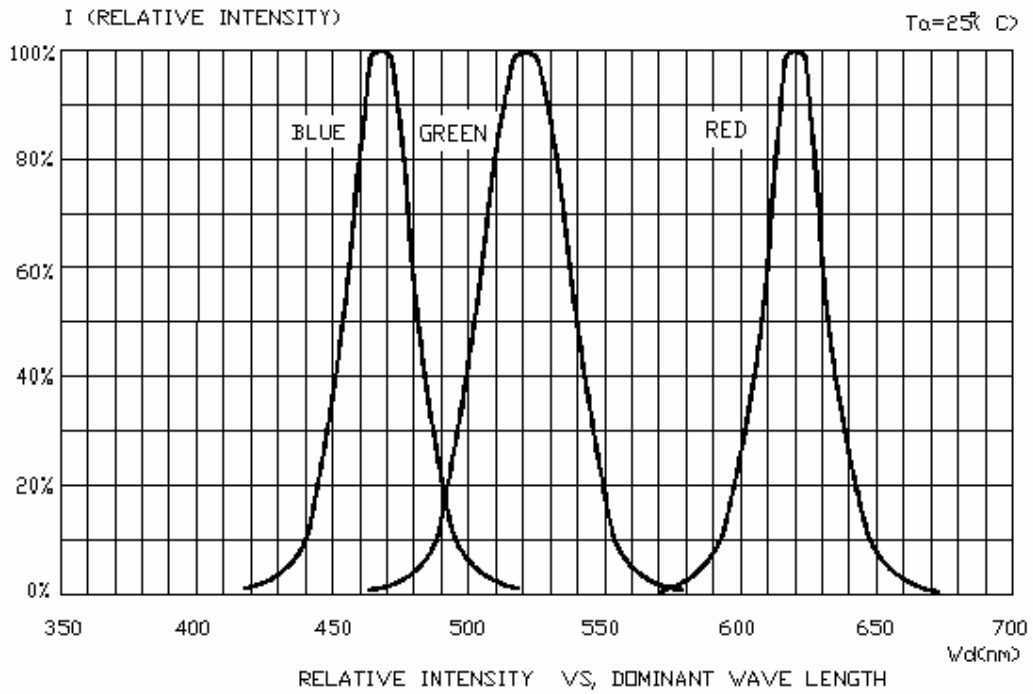

Graphs

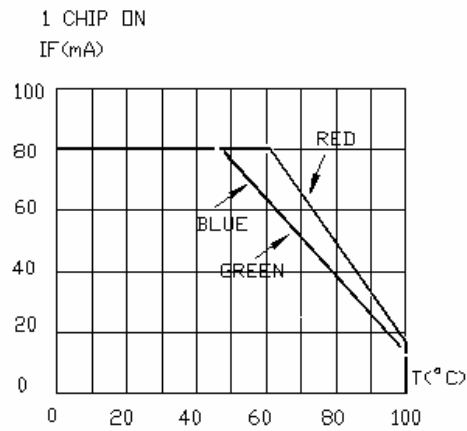
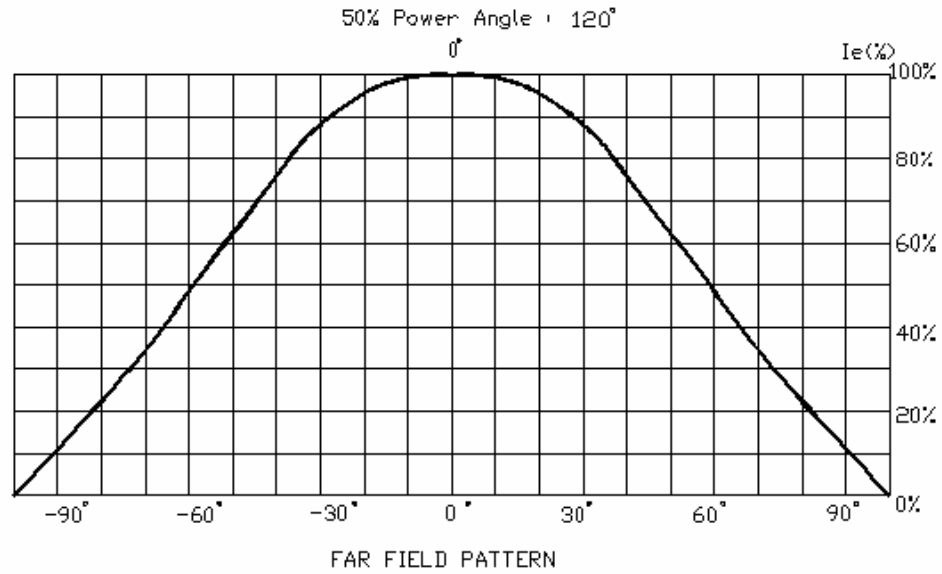

MAXIMUM FORWARD DC CURRENT
VS. SOLDER POINT TEMPERATURE.

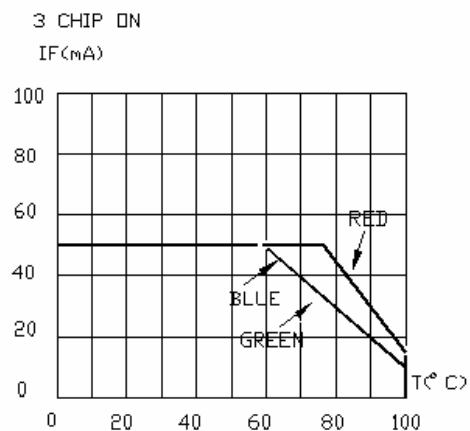

MAXIMUM FORWARD DC CURRENT
VS. SOLDER POINT TEMPERATURE.

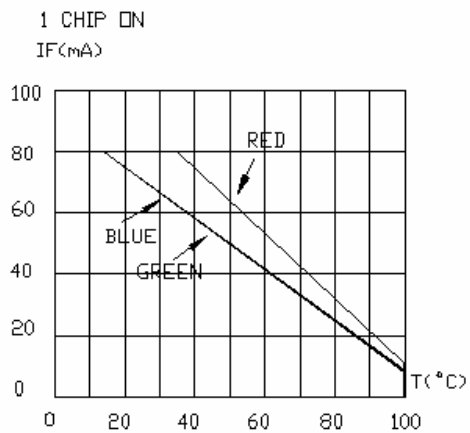

MAXIMUM FORWARD DC CURRENT
VS. AMBIENT TEMPERATURE.

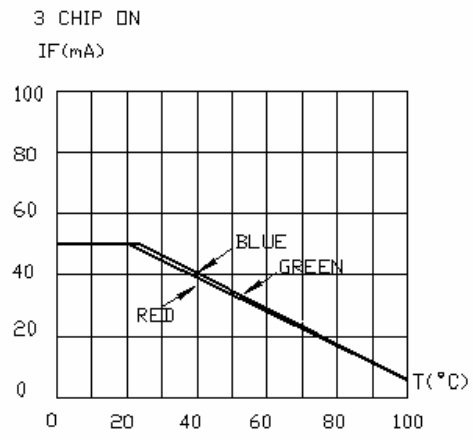

MAXIMUM FORWARD DC CURRENT
VS. AMBIENT TEMPERATURE.

Graphs

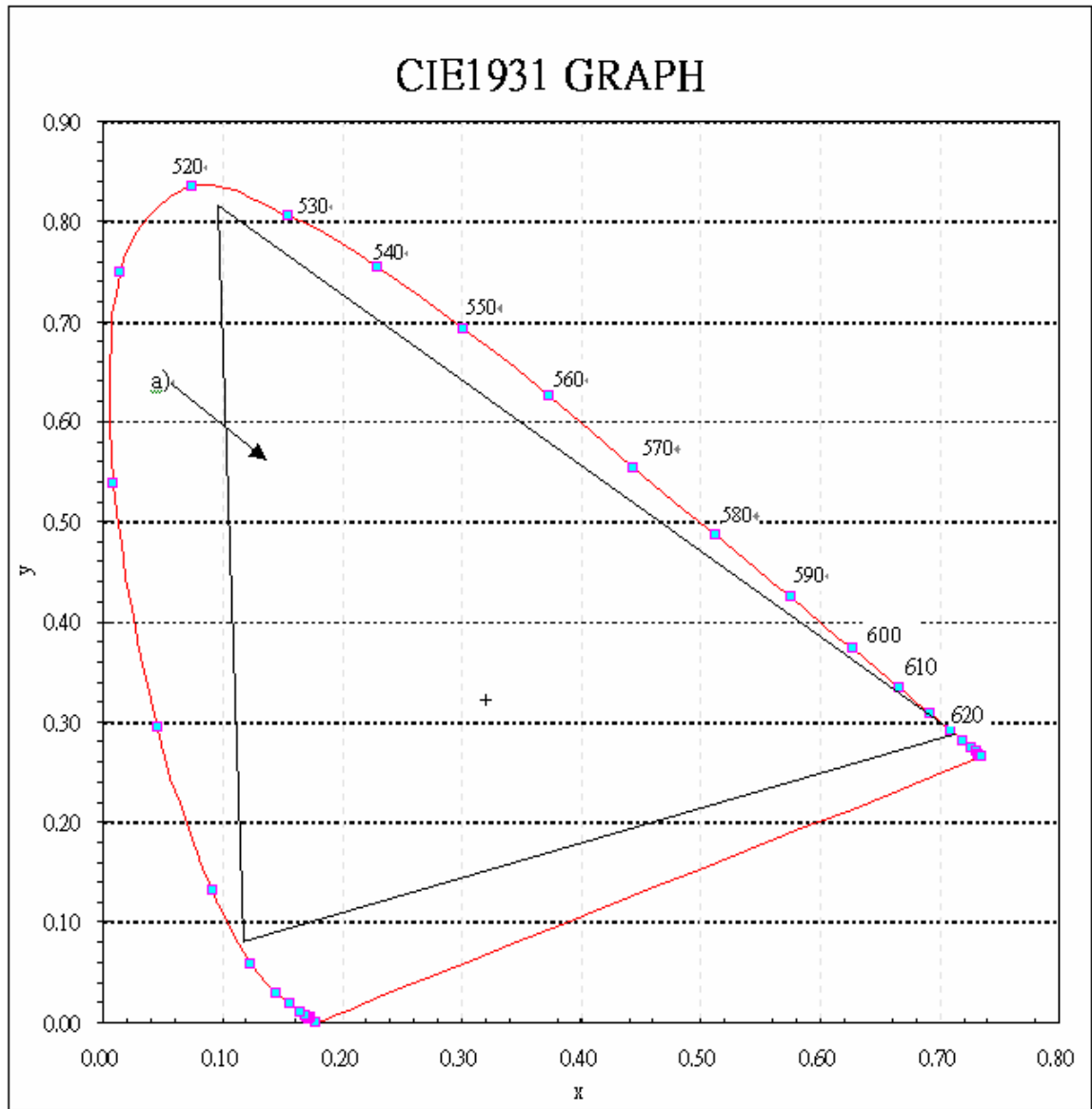

the color coordinates of the mixed light can be expected within the area of the color triangle marked a).

the achromatic point (x=0.33,y=0.33) is marked "+"

Items	Signatures	Date	Revision History		
			Rev.No	Date	Change Description
Prepared by	WangFJ	2007-03-22			
Checked by	XieJH	2007-03-22	02	2007-03-22	Delete WD rank.
Approved by	DavidLiu	2007-03-22			
FCN#	FCN20070086				

Data is subject to change without prior notice; please refer to COTCO Website for the latest version.

Copyright©2002 Cotco International Ltd.