



YJ-BC-RGBW5050-G01

High CRI LED

PRODUCT:

5050 SURFACE MOUNT RGBW LED

FEATURES:

5.5 mm × 5.0 mm x1.6 mm surface-mount LED
120° emission angle



DESCRIPTION

Yuji LED's high power RGBW 5050 allows for high brightness with individual red, green, blue and white emission control in a PLCC-6 package.



ELECTRICAL-OPTICAL CHARACTERISTICS (T _A = 25 °C)							
PARAMETER	SYMBOL	VALUE			UNIT	TOLERANCE	CONDITION
		MIN.	TYP.	MAX.			
Forward voltage	R	1.8	2.0	2.4	V	±0.05	I _f = 20mA
	G	2.8	3.3	3.6			I _f = 20mA
	B	2.8	3.3	3.6			I _f = 20mA
	W	2.8	3.3	3.6			I _f = 20mA
Dominant wavelength	λ _R	620	--	625	nm	--	I _f = 20mA
	λ _G	517.5		522.5			I _f = 20mA
	λ _B	460		465			I _f = 20mA
Intensity	Φ _{eR}	1.0	--	2.0	lm	--	I _f = 20mA
	Φ _{eG}	4.0	--	5.0	lm	--	I _f = 20mA
	Φ _{eB}	1.0	--	2.0	lm	--	I _f = 20mA
	Φ	5.0	--	6.0	lm	--	I _f = 20mA
Color rendering index (W)	Ra*	95	--	--	--	±1	I _f = 20mA
Reverse current	I _{Rr} / I _{rG} / I _{rB} / I _{rW}	--	--	5	μA	±0.1	V _r = 5V
Color temperature (W)	CCT _{2700K}	2550	2700	2850	K	--	I _f = 20mA
	CCT _{3200K}	3050	3200	3350			
	CCT _{4000K}	3800	4000	4200			
	CCT _{5000K}	4700	5000	5300			
	CCT _{5600K}	5300	5600	5900			
	CCT _{6500K}	6000	6500	7000			
Viewing angle	2θ1/2	--	120	--	Deg	±5	I _f = 20mA

*Ra minimum 93 at 6500K.



YJ-BC-RGBW5050-G01

High CRI LED

ABSOLUTE MAXIMUM RATING (T _A = 25 °C)			
PARAMETER	SYMBOL	LIMIT	UNIT
Power Consumption (Individual)	P _{DR}	48	mW
	P _{DG}	72	
	P _{DB}	72	
	P _{DW}	72	
Power Consumption (Simultaneous)	P _D	Pending	mW
DC Forward Current (Individual)	I _{FR}	24	mA
	I _{FG}	24	
	I _{FB}	24	
	I _{FW}	24	
DC Forward Current (Simultaneous)	I _F	Pending	mA
DC Forward Current (Pulsed Individual*)	I _{FP}	100	mA
Thermal resistance**	R _{θjc}	230	°C/W
Reverse Voltage	V _R	5	V
Operating Temperature	T _{opr}	-25 ~ +65	°C
Storage Temperature	T _{stg}	-30 ~ +80	°C
Soldering Temperature***	T _{sol}	240	°C
Reflow Cycles Allowed	-	3	-

* Pulse width ≤ 0.1ms, Duty ≤ 1/10.

** Soldering pad > 40mm², tested on FR4 PCB.

*** within 5 seconds on 1.2mm thickness MCPCB.



YJ-BC-RGBW5050-G01

High CRI LED

CHROMATICITY BINS & COORDINATES (White)									
CCT	BIN	CIE 1931 COORDINATES							
		X0	Y0	X1	Y1	X2	Y2	X3	Y3
6500K	B7-2	0.3115	0.3354	0.3135	0.3236	0.3193	0.3301	0.3180	0.3425
	B9-2	0.3135	0.3236	0.3155	0.3120	0.3206	0.3175	0.3193	0.3301
	B7-1	0.3058	0.3283	0.3078	0.3173	0.3135	0.3236	0.3115	0.3354
	B9-1	0.3078	0.3173	0.3100	0.3058	0.3155	0.3120	0.3135	0.3236
5600K	B8-2	0.3236	0.3459	0.3243	0.3326	0.3300	0.3390	0.3300	0.3530
	B10-2	0.3243	0.3326	0.3249	0.3194	0.3300	0.3250	0.3300	0.3390
	C3-1	0.3300	0.3530	0.3300	0.3390	0.3369	0.3450	0.3375	0.3591
	C5-1	0.3300	0.3390	0.3300	0.3250	0.3363	0.3308	0.3369	0.3450
5000K	C3-2	0.3375	0.3591	0.3369	0.3450	0.3437	0.3510	0.3449	0.3653
	C5-2	0.3369	0.3450	0.3363	0.3308	0.3426	0.3367	0.3437	0.3510
	C4-1	0.3449	0.3653	0.3437	0.3510	0.3507	0.3570	0.3524	0.3714
	C6-1	0.3437	0.3510	0.3426	0.3367	0.3491	0.3424	0.3507	0.3570
4000K	D4-1	0.3761	0.3889	0.3723	0.3727	0.3814	0.3787	0.3861	0.3957
	D4-2	0.3861	0.3957	0.3814	0.3787	0.3905	0.3848	0.3960	0.4027
	D6-1	0.3723	0.3727	0.3686	0.3565	0.3768	0.3617	0.3814	0.3787
	D6-2	0.3814	0.3787	0.3768	0.3617	0.3850	0.3669	0.3905	0.3848
3200K	F4-2	0.4237	0.4160	0.4158	0.3969	0.4259	0.4017	0.4346	0.4213
	F7-2	0.4158	0.3969	0.4081	0.3779	0.4173	0.3822	0.4259	0.4017
	F5-1	0.4346	0.4213	0.4259	0.4017	0.4388	0.4051	0.4486	0.4249
	F8-1	0.4259	0.4017	0.4173	0.3822	0.4291	0.3853	0.4388	0.4051
2700K	F6-1	0.4707	0.4306	0.4598	0.4106	0.4729	0.4139	0.4848	0.4344
	F9-1	0.4598	0.4106	0.4490	0.3906	0.4611	0.3934	0.4729	0.4139
	F5-2	0.4596	0.4275	0.4491	0.4076	0.4598	0.4106	0.4707	0.4306
	F8-2	0.4491	0.4076	0.4393	0.3879	0.4490	0.3906	0.4598	0.4106

CHROMATICITY BINS & COORDINATES

CIE 1931 COORDINATES

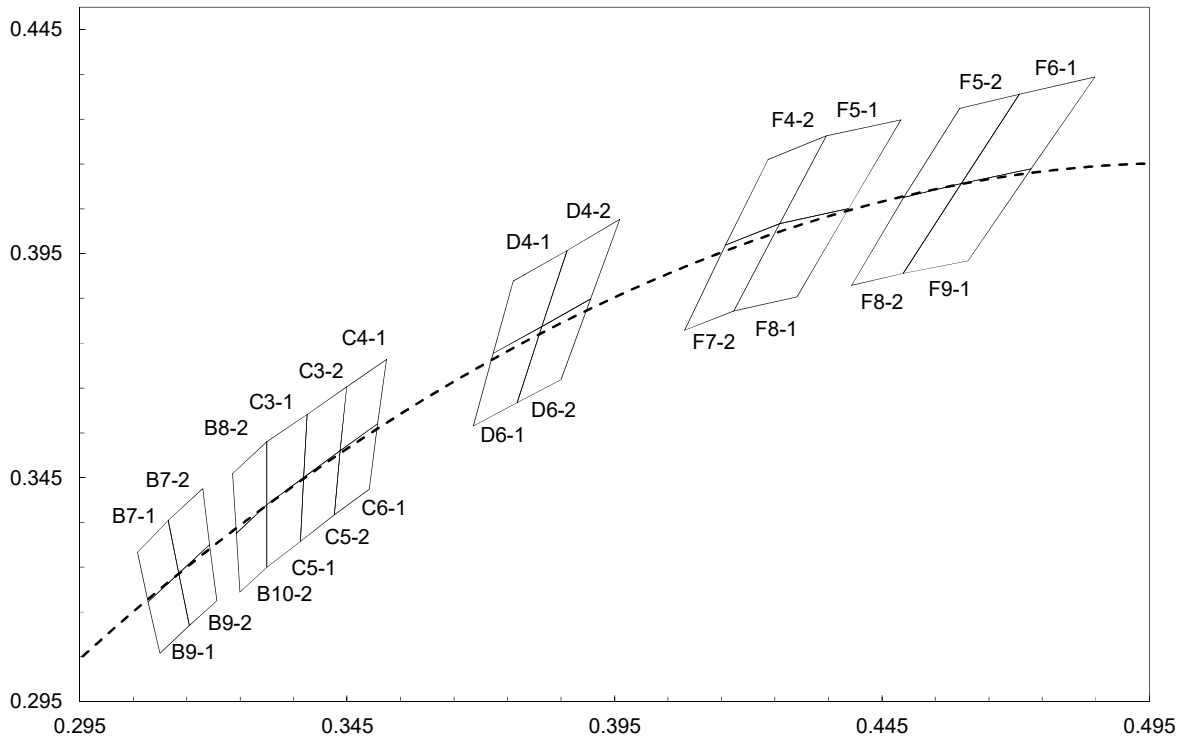

PACKAGE LAYOUT

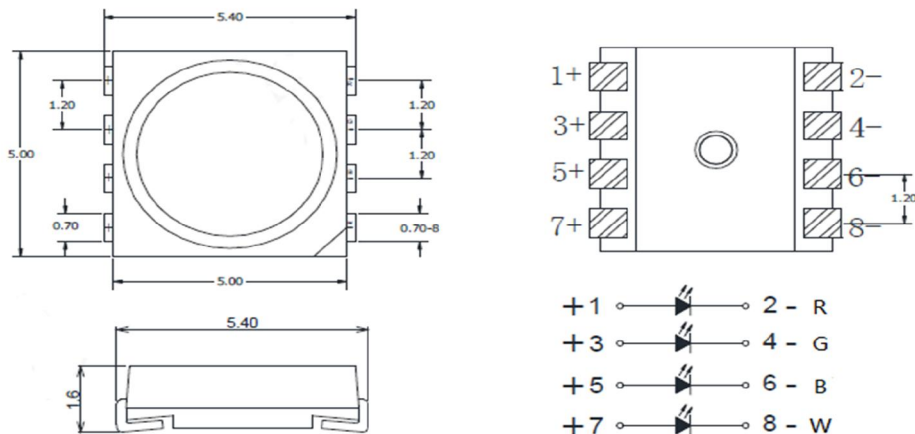



YJ-BC-RGBW5050-G01

High CRI LED

CHARACTERISTIC CURVES (G / B / W)

ALL CHARACTERISTIC CURVES ARE FOR REFERENCE ONLY AND NOT GUARANTEED

FORWARD CURRENT
VS FORWARD VOLTAGE ($T_A = 25^\circ\text{C}$)

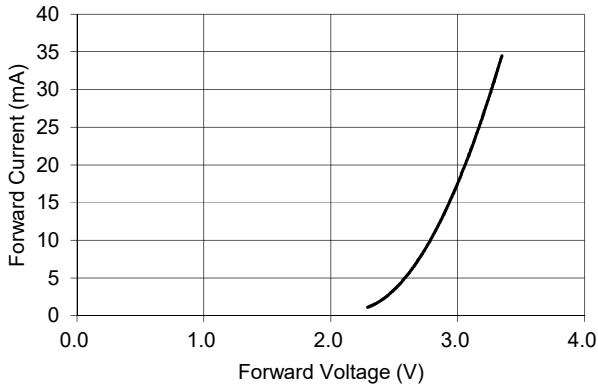

FORWARD CURRENT
VS RELATIVE LUMINOUS OUTPUT ($T_A = 25^\circ\text{C}$)

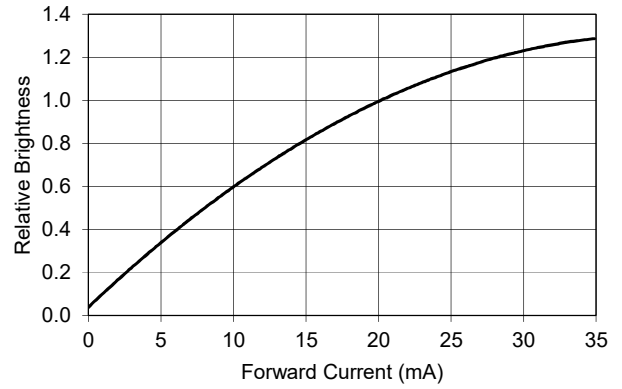

TYPICAL SPATIAL DISTRIBUTION
($T_A = 25^\circ\text{C}$, $I_F = 20\text{mA}$)

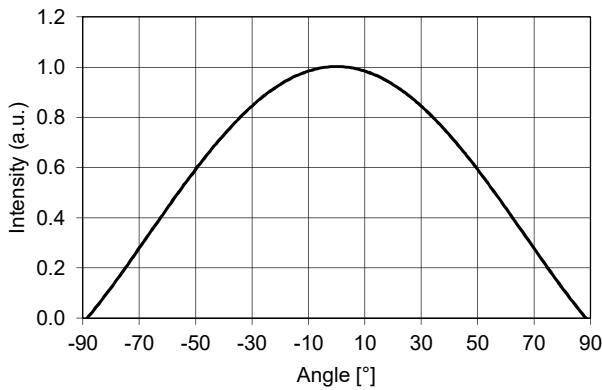

FORWARD CURRENT DERATING BASED ON SOLDER
POINT

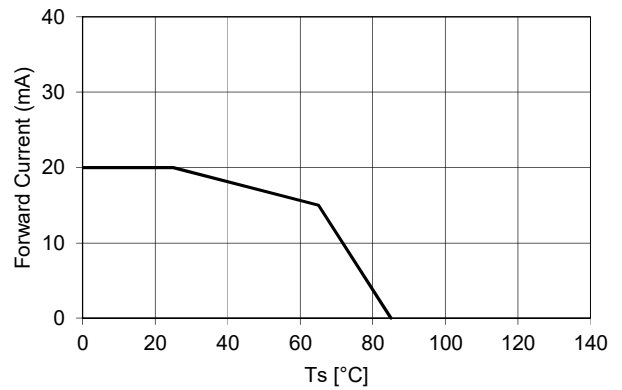

NOTE: DE-RATING CURVES ARE MEANT FOR RECOMMENDATION ONLY AND ARE NOT MEANT TO PROVIDE GUARANTEES OF PRODUCT STABILITY AND LONGEVITY



YJ-BC-RGBW5050-G01

High CRI LED

CHARACTERISTIC CURVES (R)

ALL CHARACTERISTIC CURVES ARE FOR REFERENCE ONLY AND NOT GUARANTEED

FORWARD CURRENT VS FORWARD VOLTAGE ($T_A = 25^\circ\text{C}$)

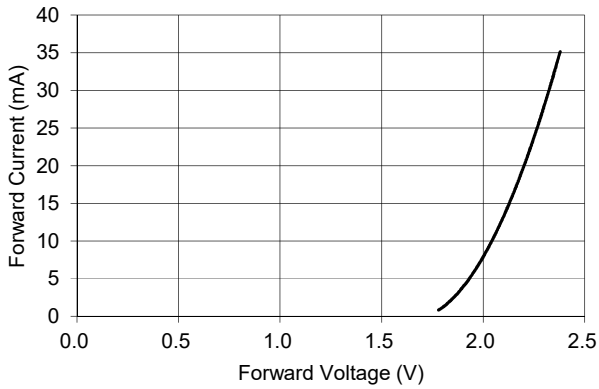

FORWARD CURRENT VS RELATIVE LUMINOUS OUTPUT ($T_A = 25^\circ\text{C}$)

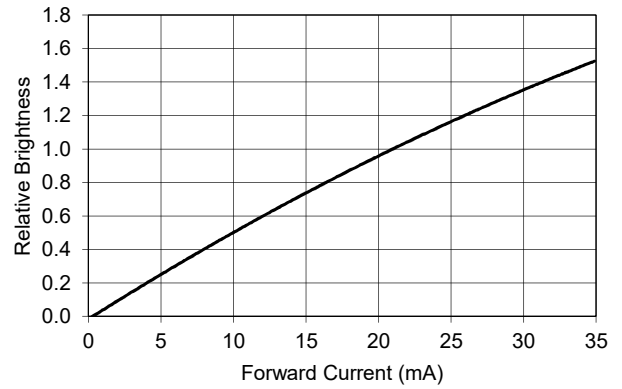

TYPICAL SPATIAL DISTRIBUTION ($T_A = 25^\circ\text{C}$, $I_F = 20\text{mA}$)

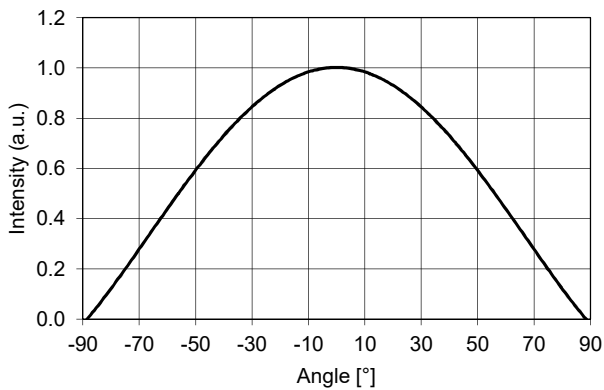

FORWARD CURRENT DERATING BASED ON SOLDER POINT

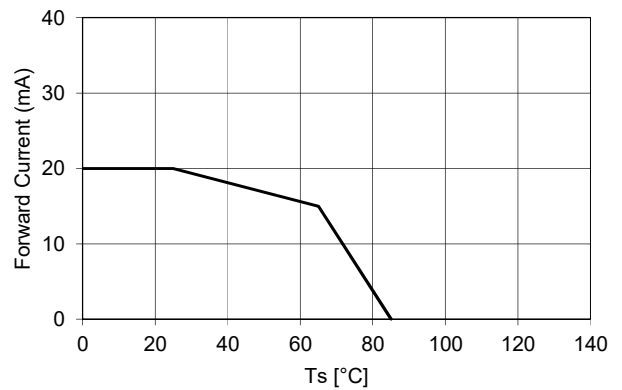

NOTE: DE-RATING CURVES ARE MEANT FOR RECOMMENDATION ONLY AND ARE NOT MEANT TO PROVIDE GUARANTEES OF PRODUCT STABILITY AND LONGEVITY



TYPICAL SPECTRAL DISTRIBUTION GRAPHS

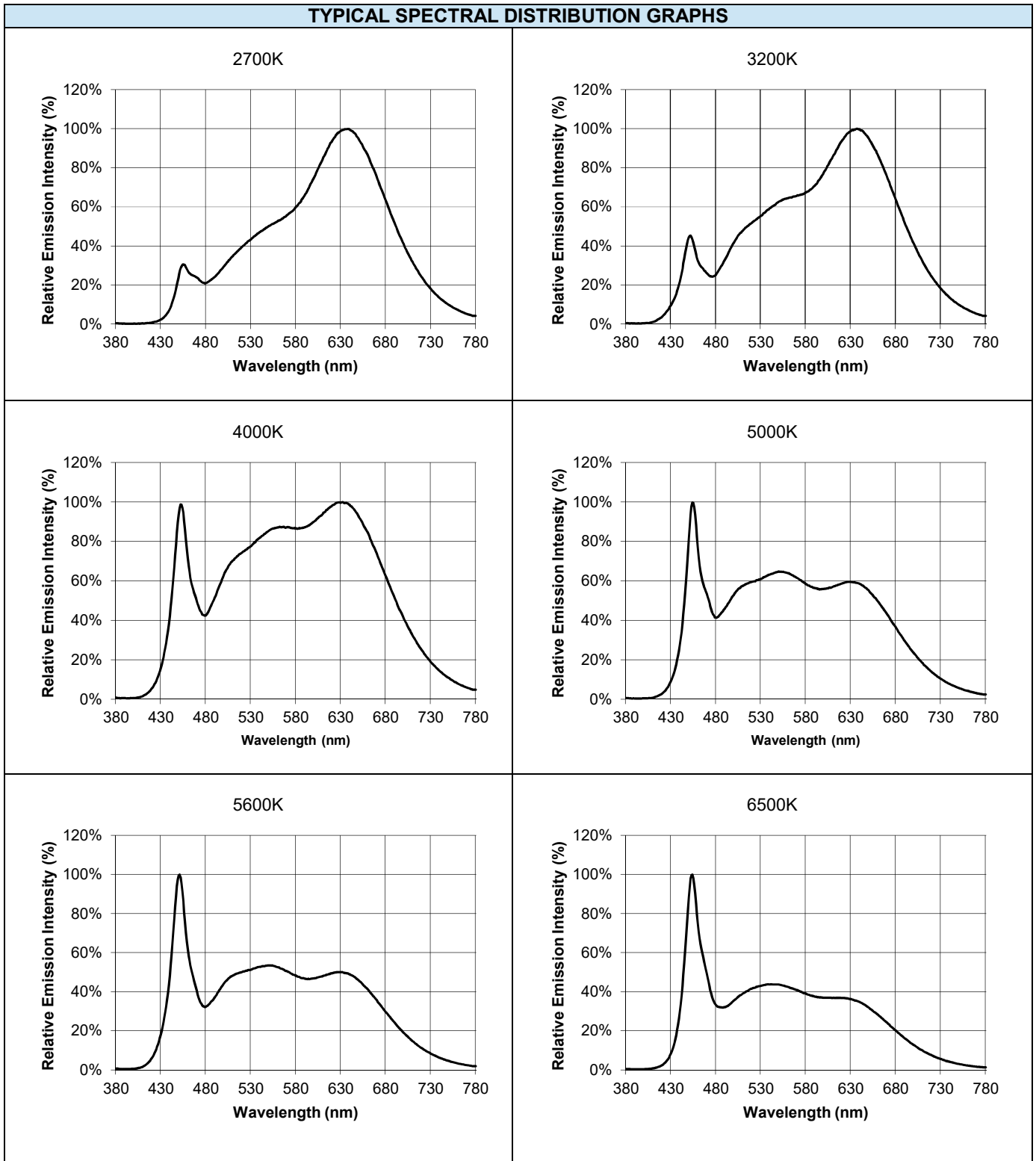



TYPICAL SPECTRAL DISTRIBUTION GRAPHS (R / G / B)

$T_A = 25^\circ\text{C}$, $I_R = 20\text{ mA}$, $I_G = 20\text{ mA}$, $I_B = 20\text{ mA}$

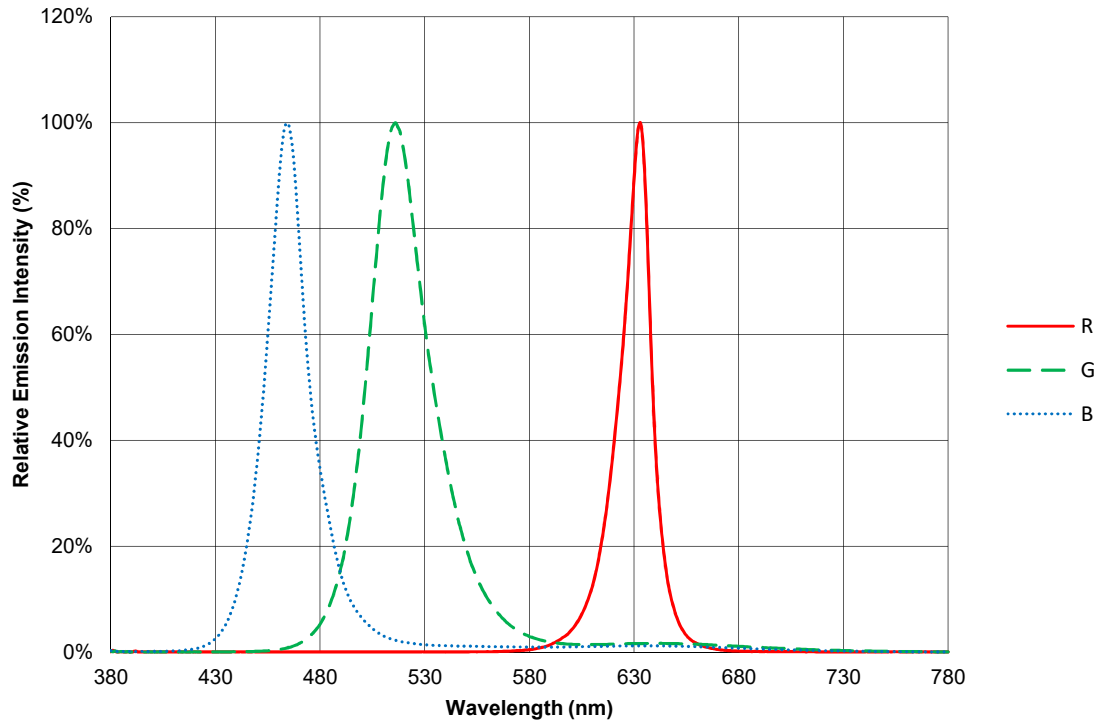

REFLOW PROFILE

SOLDERING RAMP-UP TIME (Pb-FREE)

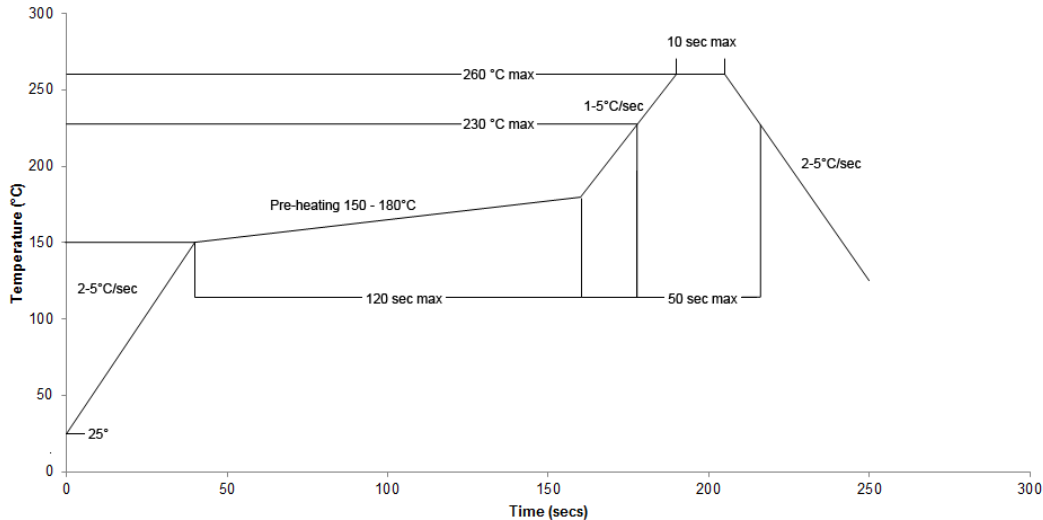

NOTE: Soldering paste with the melting point at 230°C is recommended.

INSTRUCTIONS FOR SMT

Problems caused by improper selection of collet

Choosing the right collet is important in ensuring product quality after SMT. LEDs are different from other electronic components, as they are not only concerned with electrical output but also optical output. This characteristic makes LEDs more fragile in the process of SMT. If the collet's lowering height is not well set, it will bring damage to the gold wire at the time of collet's pick-and-place process which can cause the LED to not illuminate, flicker or contribute to other quality problems, some of which may not be immediately detectable.

Collet selection

During SMT, please choose the collet that has larger outer diameter than the lighting area of lens, in order to avoid damage the gold wire inside the LED. Different collets fit for different products, please refer to the following figures below.



Setting the height of the collet is crucial in order to avoid damage to the top view SMD. If the collet setting is set to too low of an altitude, the collet will press down on the SMD, causing damage or breakage to the encapsulant and cause distortion or breakage of the gold wire.

Other notes of caution:

- No pressure should be exerted to the epoxy shell of the SMD under high temperature.
- Do not scratch or wipe the lens since the lens and gold wire inside are rather fragile and cross out easy to break.
- LED should be used as soon as possible when being taken out of the original package, and should be stored in anti-moisture and anti-ESD package.
- This usage and handling instructions are for reference only.