

NICHIA CORPORATION

SPECIFICATIONS FOR WHITE LED

NSPW310DS

• RoHS Compliant



SPECIFICATIONS

(1) Absolute Maximum Ratings

Item	Symbol	Absolute Maximum Rating	Unit
Forward Current	I_F	30	mA
Pulse Forward Current	I_{FP}	100	mA
Reverse Voltage	V_R	5	V
Power Dissipation	P_D	105	mW
Operating Temperature	T_{opr}	-30~85	°C
Storage Temperature	T_{stg}	-40~100	°C
Junction Temperature	T_J	100	°C

* Absolute Maximum Ratings at $T_A=25^\circ\text{C}$.

* I_{FP} conditions with pulse width $\leq 10\text{ms}$ and duty cycle $\leq 10\%$.

(2) Initial Electrical/Optical Characteristics

Item	Symbol	Condition	Typ	Unit
Forward Voltage	V_F	$I_F=20\text{mA}$	3.2	V
Luminous Intensity	I_v	$I_F=20\text{mA}$	6.2	cd
Chromaticity Coordinate	x	$I_F=20\text{mA}$	0.31	-
	y	$I_F=20\text{mA}$	0.32	-

* Characteristics at $T_A=25^\circ\text{C}$.

* Luminous Intensity value is traceable to the CIE 127:2007-compliant national standards.

* The Chromaticity Coordinates are derived from the CIE 1931 Chromaticity Diagram.

RANKS

Item	Rank	Min	Max	Unit
Forward Voltage	-	2.65	3.50	V
Reverse Current	-	-	50	μA
Luminous Intensity	W	6.51	9.22	cd
	V	4.61	6.51	
	U	3.25	4.61	

Color Ranks

	Rank a0			
x	0.280	0.264	0.283	0.296
y	0.248	0.267	0.305	0.276

	Rank b1			
x	0.283	0.287	0.330	0.330
y	0.305	0.295	0.339	0.360

	Rank b2			
x	0.296	0.287	0.330	0.330
y	0.276	0.295	0.339	0.318

	Rank c0			
x	0.330	0.330	0.361	0.356
y	0.318	0.360	0.385	0.351

* Ranking at $T_A=25^{\circ}\text{C}$.

* Reverse Current at $V_R=5\text{V}$.

* Tolerance of measurements of the Forward Voltage is $\pm 3\%$.

* Tolerance of measurements of the Luminous Intensity is $\pm 10\%$.

* Tolerance of measurements of the Chromaticity Coordinate is ± 0.01 .

* Basically, a shipment shall consist of the LEDs of a combination of the above ranks.

The percentage of each rank in the shipment shall be determined by Nichia.

CHROMATICITY DIAGRAM

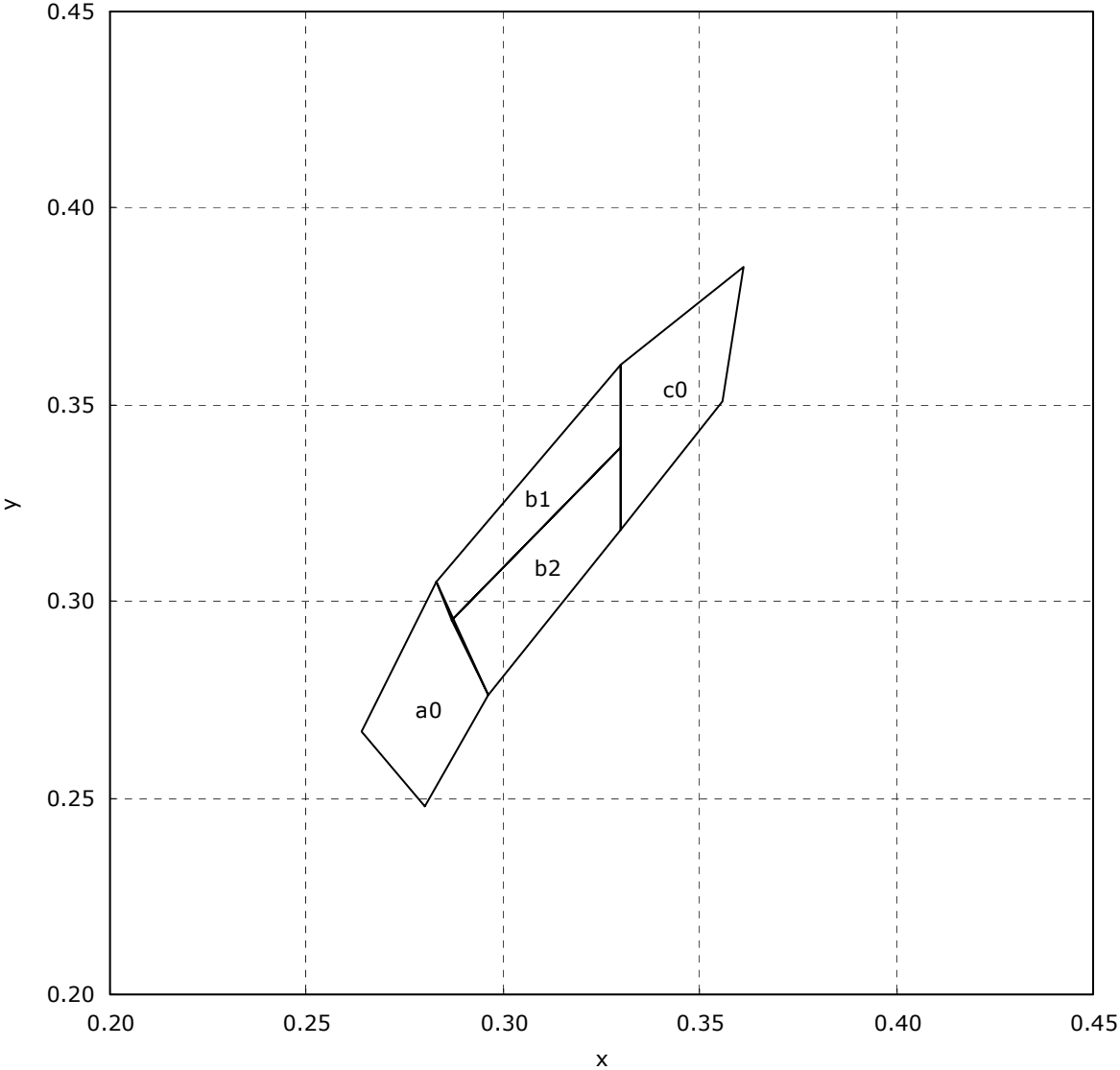

OUTLINE DIMENSIONS

* 本製品はRoHS指令に適合しております。
This product complies with RoHS Directive.

NSPW310DS
管理番号 No. STS-DA7-0347

(単位 Unit: mm, 公差 Tolerance: ±0.2)

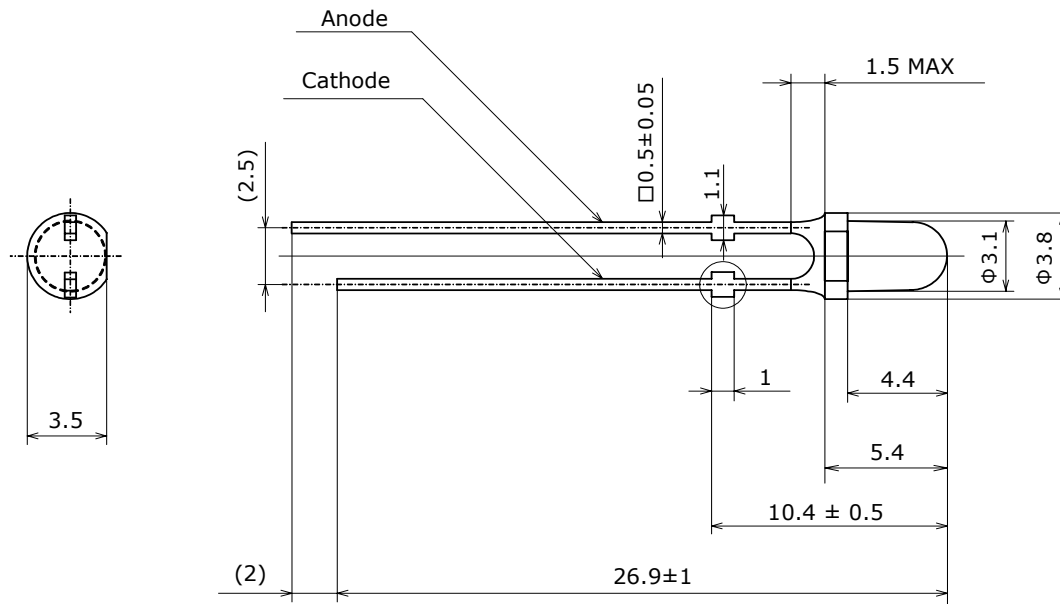

項目 Item	内容 Description
樹脂材質 Resin Materials	エポキシ樹脂(一部蛍光体入り) Epoxy Resin(partly using phosphor)
リードフレーム材質 Lead Frame Materials	銅合金+銀メッキ Ag-plated Copper Alloy
質量 Weight	0.17g(TYP)

ストッパー部詳細図
Lead Standoff

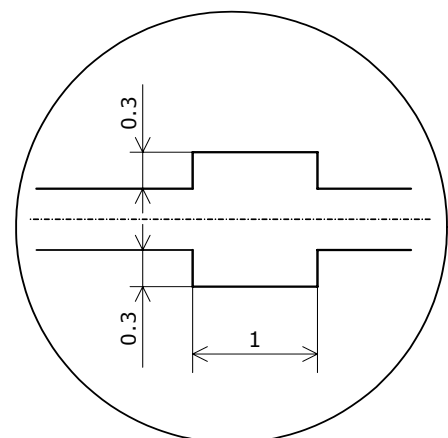

* タイバーを切り取った部分は銅合金が露出しております。
またLEDには鋭利な部分があります。特にリード部分は、人体を傷つける
ことがありますので、取り扱いに際しては十分注意して下さい。
The tie bar cut-end surface exhibits exposed copper alloy base metal.
Care must be taken to handle the LEDs, as it may contain sharp parts
such as lead, and can cause injury.

SOLDERING

- Hand Soldering

Temperature	350°C Max
Soldering Time	3sec Max
Position	No closer than 3mm from the base of the lens.

- Dip Soldering

Pre-Heat	120°C Max
Pre-Heat Time	60sec Max
Solder Bath Temperature	260°C Max
Dipping Time	10sec Max
Dipping Position	No closer than 3mm from the base of the lens.

- * For a better thermal performance, copper alloy is used for the leadframe of the product.
Care must be taken for the soldering conditions and handling of the products after soldering.
- * Solder the LED no closer than 3mm from the base of the lens.
Soldering beyond the base of the tie bar is recommended.
- * Dip soldering and manual soldering must only be done once.
- * Care should be taken to avoid cooling at a rapid rate and ensure the peak temperature ramps down slowly.
- * Do not apply any stress to the lead particularly when heated.
- * After soldering, the LED position must not be corrected.
- * After soldering, NO mechanical shock or vibration should be applied to LED lens until the LEDs cool down to room temperature.
- * In order to avoid damage on the lens during cutting and clinching the leads, it is not recommended to solder the LEDs directly on customer PCB without any gap between the lens and the board.
If it is unavoidable, customer is advised to check whether such soldering will not cause wire breakage or lens damage.
Direct soldering to double-sided PCBs must be avoided due to an increased effect of heat on the lens.
- * When it is necessary to clamp the LEDs to prevent soldering failure, it is important to minimize the mechanical stress on the LEDs.
- * Cut the LED lead frames at room temperature. Cutting the lead frames at high temperature may cause failure of the LEDs.

PACKAGING - BULK

Nxxxxxxx
管理番号 No. STS-DA7-0001A

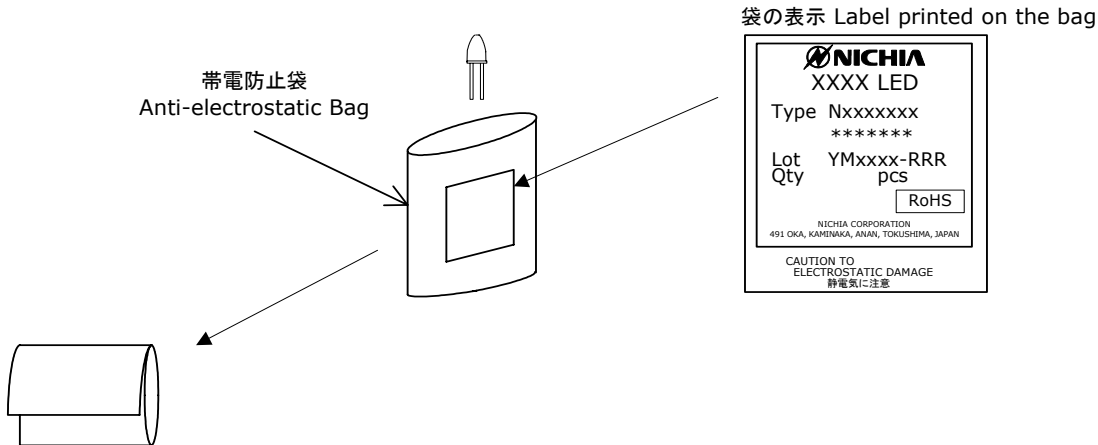

帯電防止袋を並べて入れ、ダンボールで仕切ります。
The anti-electrostatic bags are packed in a cardboard box with corrugated partition.

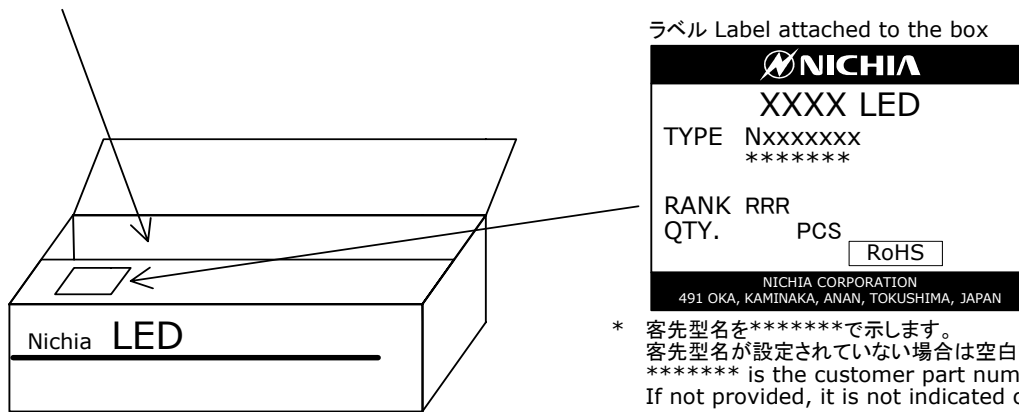

- * 客先型名を*****で示します。
客先型名が設定されていない場合は空白です。
***** is the customer part number.
If not provided, it is not indicated on the label.
- * ロット表記方法についてはロット番号の項を参照して下さい。
For details, see "LOT NUMBERING SCHEME" in this document.

- * 本製品は帯電防止袋に入れたのち、輸送の衝撃から保護するためダンボールで梱包します。
The products are placed loose in anti-static bags.
The anti-static bags are packed in cardboard boxes to prevent damage during shipment.
- * 取り扱いに際して、落下させたり、強い衝撃を与えたりしますと、製品を損傷させる原因になりますので注意して下さい。
Do not drop the cardboard box or expose it to shock. If the box falls, the products could be damaged.
- * ダンボールには防水加工がされておりませんので、梱包箱が水に濡れないよう注意して下さい。
The cardboard box is not water-resistant. Do not expose to water.
- * 輸送、運搬に際して弊社よりの梱包状態あるいは同等の梱包を行って下さい。
Customer is advised to pack the products in the original packaging or equivalent in transit.

LOT NUMBERING SCHEME

Lot Number is presented by using the following alphanumeric code.

YMxxxx - RRR

Y - Year

Year	Y
2009	9
2010	A
2011	B
2012	C
2013	D
2014	E

M - Month

Month	M	Month	M
1	1	7	7
2	2	8	8
3	3	9	9
4	4	10	A
5	5	11	B
6	6	12	C

xxxx-Nichia's Product Number

RRR-Ranking by Color Coordinates, Ranking by Luminous Intensity

DERATING CHARACTERISTICS

NSPW310D(S)
 管理番号 No. STS-DA7-0598

周囲温度-許容順電流特性
 Ambient Temperature vs
 Allowable Forward Current

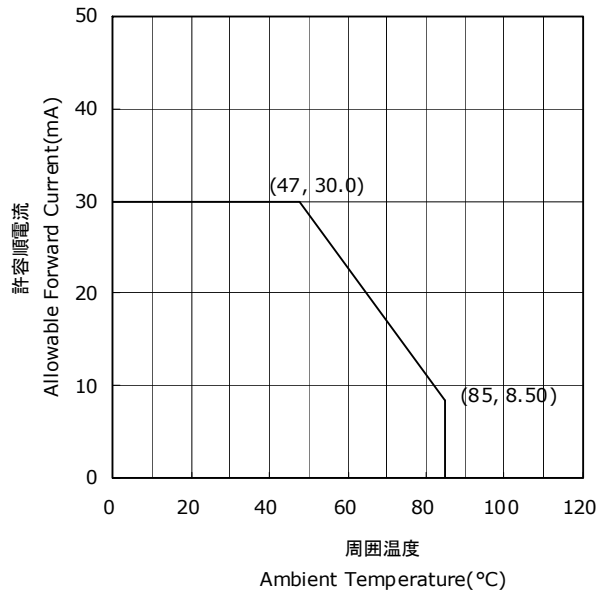

デューティー比-許容順電流特性
 Duty Ratio vs
 Allowable Forward Current

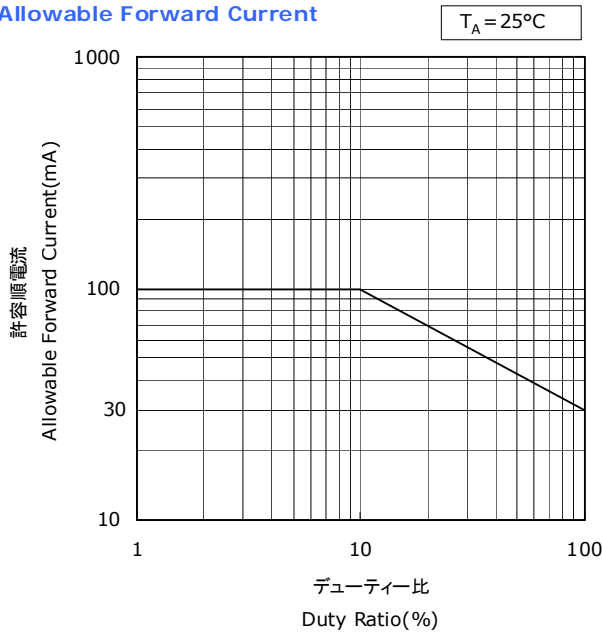

OPTICAL CHARACTERISTICS

* 本特性は参考です。
All characteristics shown are for reference only and are not guaranteed.

NSPW310D(S)
管理番号 No. STS-DA7-0769

発光スペクトル Spectrum

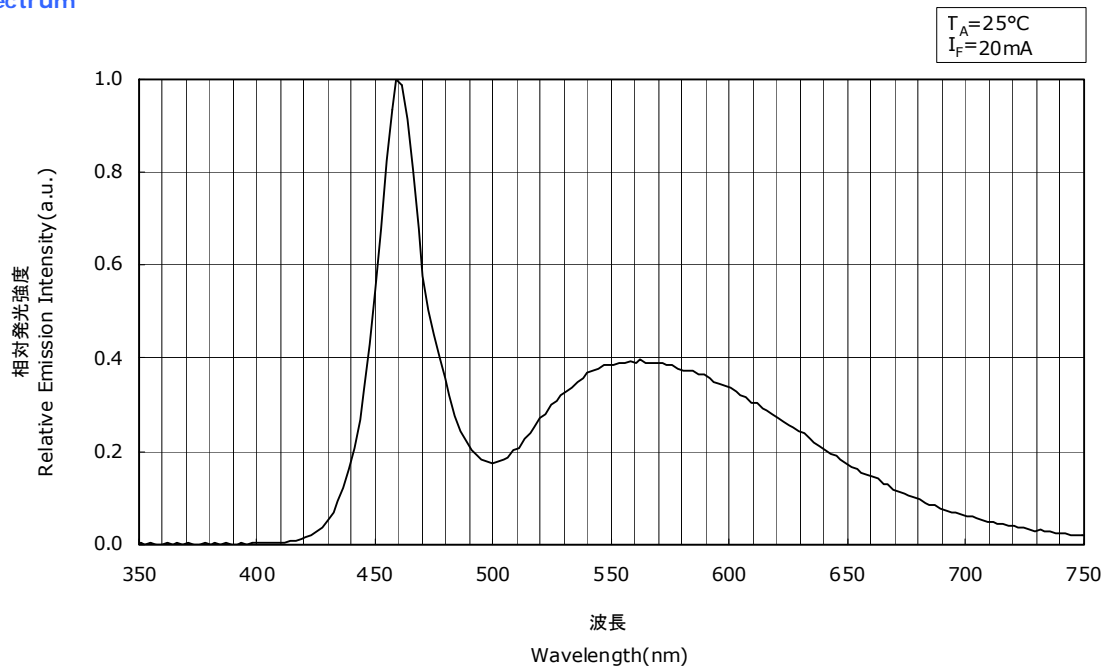

指向特性 Directivity

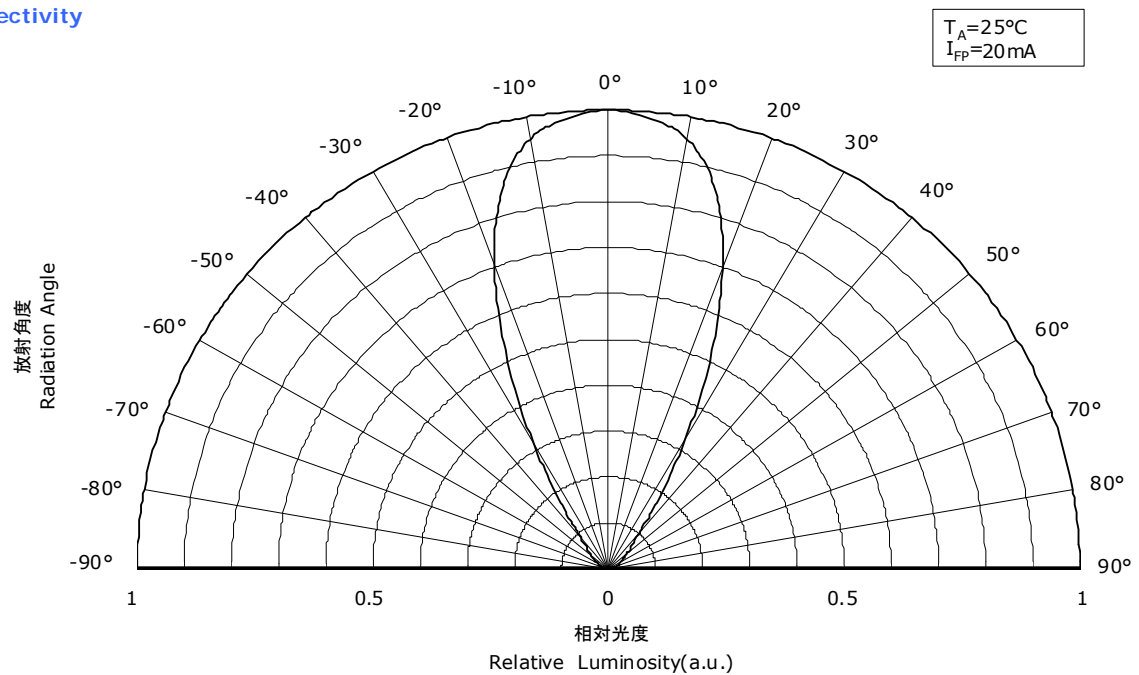

FORWARD CURRENT CHARACTERISTICS / TEMPERATURE CHARACTERISTICS

* 本特性は参考です。
All characteristics shown are for reference only and are not guaranteed.

NSPW310D(S)
管理番号 No. STS-DA7-0770

順電圧-順電流特性
Forward Voltage vs
Forward Current

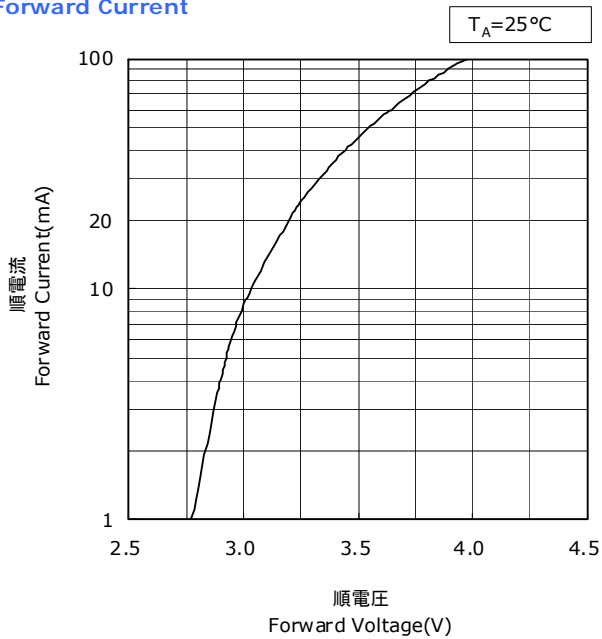

周囲温度-順電圧特性
Ambient Temperature vs
Forward Voltage

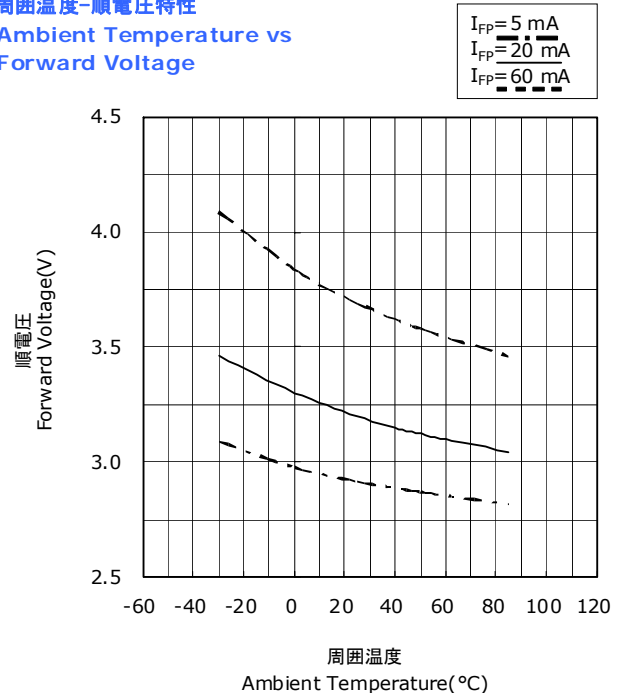

順電流-相対光度特性
Forward Current vs
Relative Luminosity

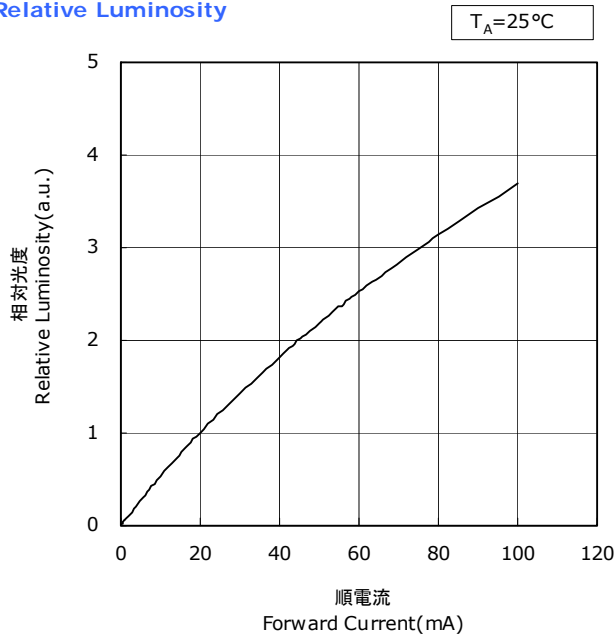

周囲温度-相対光度特性
Ambient Temperature vs
Relative Luminosity

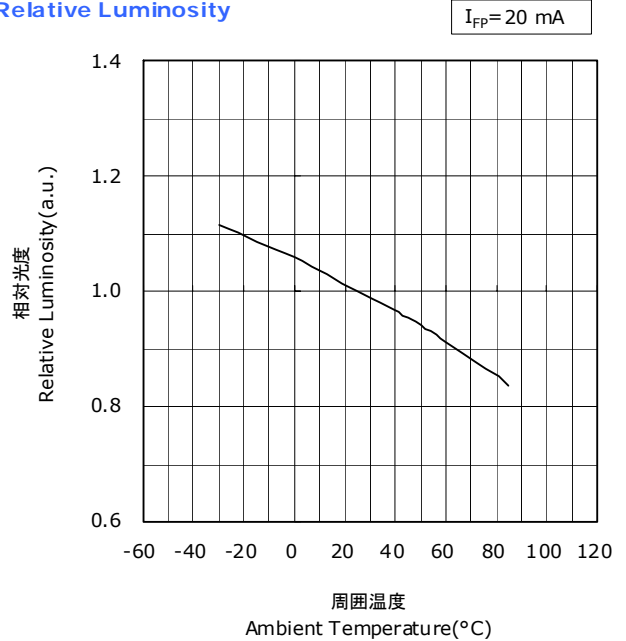

FORWARD CURRENT CHARACTERISTICS / TEMPERATURE CHARACTERISTICS

* 本特性は参考です。

All characteristics shown are for reference only and are not guaranteed.

NSPW310D(S)
管理番号 No. STS-DA7-0771

順電流-色度特性
Forward Current vs Chromaticity Coordinate

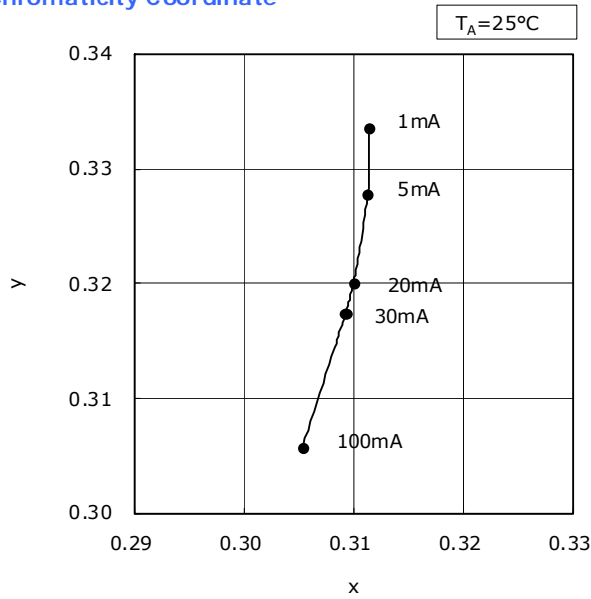

周囲温度-色度特性
Ambient Temperature vs Chromaticity Coordinate

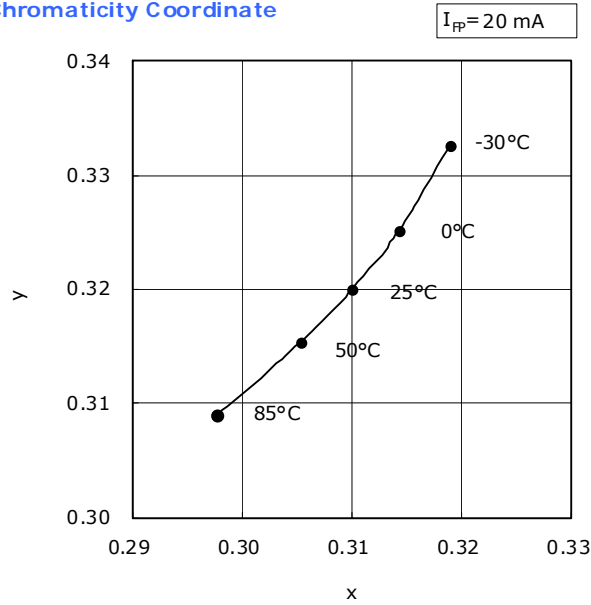

RELIABILITY

(1) Tests and Results

Test	Reference Standard	Test Conditions	Test Duration	Failure Criteria #	Units Failed/Tested
Resistance to Soldering Heat	JEITA ED-4701 300 302	$T_{\text{sid}}=260\pm 5^{\circ}\text{C}$, 10sec, 1dip, 3mm from the base of the lens		#1	0/50
Solderability	JEITA ED-4701 303 303A	$T_{\text{sid}}=245\pm 5^{\circ}\text{C}$, 5sec, Lead-free Solder(Sn-3.0Ag-0.5Cu)		#2	0/50
Temperature Cycle	JEITA ED-4701 100 105	$-40^{\circ}\text{C}(30\text{min})\sim 25^{\circ}\text{C}(5\text{min})\sim$ $100^{\circ}\text{C}(30\text{min})\sim 25^{\circ}\text{C}(5\text{min})$	100cycles	#1	0/50
Moisture Resistance (Cyclic)	JEITA ED-4701 200 203	$25^{\circ}\text{C}\sim 65^{\circ}\text{C}\sim -10^{\circ}\text{C}$, 90%RH, 24hr per cycle	10cycles	#1	0/50
Terminal Bend Strength	JEITA ED-4701 400 401	5N, $0^{\circ}\sim 90^{\circ}\sim 0^{\circ}$ bend, 2bending cycles		#1	0/50
Terminal Pull Strength	JEITA ED-4701 400 401	10N, $10\pm 1\text{sec}$		#1	0/50
High Temperature Storage	JEITA ED-4701 200 201	$T_{\text{A}}=100^{\circ}\text{C}$	1000hours	#1	0/50
Temperature Humidity Storage	JEITA ED-4701 100 103	$T_{\text{A}}=60^{\circ}\text{C}$, RH=90%	1000hours	#1	0/50
Low Temperature Storage	JEITA ED-4701 200 202	$T_{\text{A}}=-40^{\circ}\text{C}$	1000hours	#1	0/50
Room Temperature Operating Life		$T_{\text{A}}=25^{\circ}\text{C}$, $I_{\text{F}}=30\text{mA}$	1000hours	#1	0/50
Temperature Humidity Operating Life		60°C , RH=90%, $I_{\text{F}}=20\text{mA}$	500hours	#1	0/50
Low Temperature Operating Life		$T_{\text{A}}=-30^{\circ}\text{C}$, $I_{\text{F}}=20\text{mA}$	1000hours	#1	0/50

NOTES:

Measurements are performed after allowing the LEDs to return to room temperature.

(2) Failure Criteria

Criteria #	Items	Conditions	Failure Criteria
#1	Forward Voltage(V_{F})	$I_{\text{F}}=20\text{mA}$	$> \text{U.S.L.} \times 1.1$
	Luminous Intensity(I_{V})	$I_{\text{F}}=20\text{mA}$	$< \text{L.S.L.} \times 0.7$
	Reverse Current(I_{R})	$V_{\text{R}}=5\text{V}$	$> \text{U.S.L.} \times 2.0$
#2	Solderability	-	Less than 95% solder coverage

U.S.L. : Upper Specification Limit L.S.L. : Lower Specification Limit

CAUTIONS

(1) Lead Forming

- When forming leads, the leads should be bent at a point at least 3mm from the base of the epoxy bulb.
Do not use the base of the leadframe as a fulcrum during lead forming.
- Lead forming should be done before soldering.
- Do not apply any bending stress to the base of the lead.
The stress to the base may damage the LED's characteristics or it may break the LEDs.
- When mounting the product onto a printed circuit board, the via-holes on the board should be exactly aligned with the lead pitch of the product. If the LEDs are mounted with stress at the leads, it causes deterioration of the epoxy resin and this will degrade the LEDs.

(2) Storage

- Shelf life of the products in unopened bag is 3 months(max.) at <math><30^{\circ}\text{C}</math> and 70% RH from the delivery date.
If the shelf life exceeds 3 months or more, the LEDs need to be stored in a sealed container with desiccant (silica gel) to ensure their shelf life will not exceed 1 year.
- Nichia LED leadframe are silver plated copper alloy. This silver surface may be affected by environments which contain corrosive substances. Please avoid conditions which may cause the LED to corrode, tarnish or discolor.
This corrosion or discoloration may cause difficulty during soldering operation.
It is recommended that the LEDs be used as soon as possible.
- To avoid condensation, the products must not be stored in the areas where temperature and humidity fluctuate greatly.

(3) Directions for Use

- In designing a circuit, the current through each LED must not exceed the Absolute Maximum Rating specified for each LED.
It is recommended to use Circuit B which regulates the current flowing through each LED. In the meanwhile, when driving LEDs with a constant voltage in Circuit A, the current through the LEDs may vary due to the variation in Forward Voltage characteristics of the LEDs.

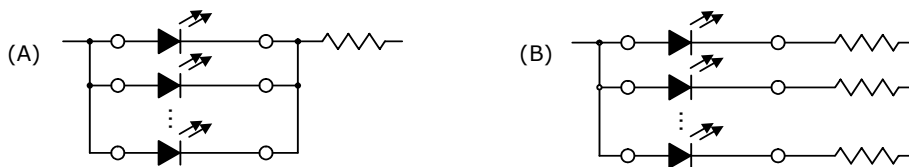

- This product should be operated in forward bias. A driving circuit must be designed so that the product is not subjected to either forward or reverse voltage while it is off. In particular, if a reverse voltage is continuously applied to the product, such operation can cause migration resulting in LED damage.
- For stabilizing the LED characteristics, it is recommended to operate at 10% of the rated current or higher.
- Care must be taken to ensure that the reverse voltage will not exceed the Absolute Maximum Rating when using the LEDs with matrix drive.
- For outdoor use, necessary measures should be taken to prevent water, moisture and salt air damage.

(4) Handling Precautions

- When handling the product, do not touch it directly with bare hands as it may contaminate the surface and affect on optical characteristics. In the worst cases, excessive force to the product might result in catastrophic failure due to package damage and/or wire breakage.
- If the product is dropped, it might be damaged.
- Do not stack assembled PCBs together. Failure to comply can cause the resin portion of the product to be cut, chipped, delaminated and/or deformed, and wire to be broken, and thus resulting in catastrophic failure.

(5) Design Consideration

- PCB warpage after mounting the products onto a PCB can cause the package to break.
The LEDs should be placed so as to minimize the stress on the LEDs due to PCB bow and twist.
- The position and orientation of the LEDs affect how much mechanical stress is exerted on the LEDs placed near the score lines.
The LEDs should be placed so as to minimize the stress on the LEDs due to board flexing.
- Board separation must be performed using special jigs, not with hands.

(6) Electrostatic Discharge (ESD)

- The products are sensitive to static electricity or surge voltage. An ESD event may damage its die or reduce its reliability performance. When handling the products, measures against electro static discharge, including the followings, are strongly recommended.
 - Eliminating the charge;
 - Wrist strap, ESD footwear and garments, ESD floors
 - Grounding the equipment and tools at workstation
 - ESD table/shelf mat (conductive materials)
- Proper grounding techniques are required for all devices, equipment and machinery used in the assembly of the products. Also note that surge protection should be considered in the design of customer products.
- If tools or equipment contain insulating materials, such as glass or plastic, proper measures against electro static discharge, including the followings, are strongly recommended.
 - Dissipating the charge with conductive materials
 - Preventing the charge generation with moisture
 - Neutralizing the charge with ionizers
- When performing the characteristics inspection of the LEDs in your application, customer is advised to check on the LEDs whether or not they are damaged by ESD. Such damage can be detected during forward voltage measurement or light up test at low current. (the recommended current is 1mA or lower)
- ESD-damaged LEDs may have an increased leakage current, current flow at low voltage, or no longer light up at low current.
 - Failure Criteria: $V_F < 2.0V$ at $I_F = 0.5mA$

(7) Thermal Management

- Thermal management is an important factor when designing your product by using the LEDs.
 - The rise in LED die temperature can be affected by PCB thermal resistance or/and LED spacing as mounted on the board. Customer is advised to design the product to ensure that the LED die temperature does not exceed the required maximum Junction Temperature (T_J).
- Drive current should be determined for the surrounding ambient temperature (T_A) to dissipate the heat from the product.

(8) Cleaning

- If required, isopropyl alcohol (IPA) should be used. Other solvents may cause premature failure to the LEDs due to the damage to the resin portion. The effects of such solvents should be verified prior to use.
 - In addition, the use of CFCs such as Freon is heavily regulated.
- Ultrasonic cleaning is not recommended for the LEDs since it may adversely effect on the LEDs by the ultrasonic power and LED assembled condition.
 - If it is unavoidable, customer is advised to check prior to use that the cleaning will not damage the LEDs.

(9) Eye Safety

- The International Electrical Commission (IEC) published in 2006, IEC 62471:2006 Photobiological safety of lamps and lamp systems which includes LEDs within its scope. Meanwhile LEDs were removed from the scope of the IEC 60825-1:2007 laser safety standard, the 2001 edition of which included LED sources within its scope. However, keep it mind that some countries and regions have adopted standards based on the IEC laser safety standard IEC 60825-1:2001 which includes LEDs within its scope. Following IEC 62471:2006, most of Nichia LEDs can be classified as belonging to either Exempt Group or Risk Group 1. Especially a high-power LED, that emits light containing blue wavelengths, may be in Risk Group 2. Great care should be taken when viewing directly the LED driven at high current or the LED with optical instruments, which greatly increase the hazard to your eyes.
- Viewing a flashing light may cause eye discomfort. When incorporating the LED into your product, precaution should be taken to avoid adverse effect on human body caused by the light stimulus.

(10) Others

- The LEDs described in this brochure are intended to be used for ordinary electronic equipment (such as office equipment, communications equipment, measurement instruments and household appliances).
Consult Nichia's sales staff in advance for information on the applications in which exceptional quality and reliability are required, particularly when the failure or malfunction of the LEDs may directly jeopardize life or health (such as for airplanes, aerospace, submersible repeaters, nuclear reactor control system, automobiles, traffic control equipment, life support systems and safety devices).
- The customer shall not reverse engineer by disassembling or analysis of the LEDs without having prior written consent from Nichia. When defective LEDs are found, the customer shall inform Nichia directly before disassembling or analysis.
- Customer and Nichia shall agree the official specification of supplied products prior to the start of a customer's volume production.
- The appearance and specifications of the product may be modified for improvement without notice.