

Product Specification

Product Code: VPC161

Product	Surface Mount Type UV-LED (Mounted on Cu Board) 280 nm
Title	Product Specification
Document No.	NKSUV-AD01-0070
Version	0.0
Issue Date	Apr. 27, 2017

NIKKISO GIKEN Co., Ltd.

NKSUV-AD01-0070

Table of Contents

	Page
1. Product Description	3
2. Intended Use	3
3. Product Code	3
4. Absolute Maximum Ratings.....	3
5. Electrical and Optical Characteristics	3
6. Environmental Compliance.....	3
7. Electrostatic Discharge (ESD) Protection.....	3
8. Reference Data and Derating Curve	4
9. Outline Dimensions, Main Materials and Electric Circuit.....	5
10. Serial Numbering Code	7
11. Packaging	8
12. Cautions.....	10

1. Product Description: Surface mount type, high-power deep-ultraviolet light emitting diode
(mounted on Cu board)

2. Intended Use: Deep-ultraviolet light source.

Caution: This product can only be used as a deep-ultraviolet light source.

3. Product Code

Peak Wavelength	Product Code
280 nm	VPC161

4. Absolute Maximum Ratings

Parameter	Symbol	Unit	Absolute Maximum Ratings	Remark
Forward Current	I_F	mA	500	$T_s = 25 \text{ deg C}$
Operating Temperature	T_{opr}	deg C	-10 to 55	-
Storage Temperature	T_{stg}	deg C	-30 to 85	-
Junction Temperature	T_j	deg C	100	-

T_s : Temperature at solder point

5. Electrical and Optical Characteristics ($I_F = 350 \text{ mA}$, $T_s = 25 \text{ deg C}$)

Parameter	Symbol	Unit	Min.	Typ.	Max.	Remark
Forward Voltage	V_F	V	4.5	5.6	7.0	-
Peak Wavelength	λ_P	nm	275	280	285	-
Radiant Flux	P_O	mW	20	25	-	-
Spectrum Half Width (FWHM)	$\Delta\lambda$	nm	-	13	20	-
Viewing Angle	2 θ 1/2	deg.	-	130	-	-
Thermal Resistance	$R_{J.s}$	deg C / W	-	15	18	-

6. Environmental Compliance

This product is RoHS and REACH compliant.

7. Electrostatic Discharge (ESD) Protection

ESD protection device is built in this product.

ESD Protection Voltage Level: $\pm 2.0 \text{ kV}$ (HBM, $1.5 \text{ k}\Omega$, 100 pF)

8. Reference Data and Derating Curve

Note: All characteristics shown in this section are for reference only and are not guaranteed.

■ Forward Current vs Relative Radiant Flux

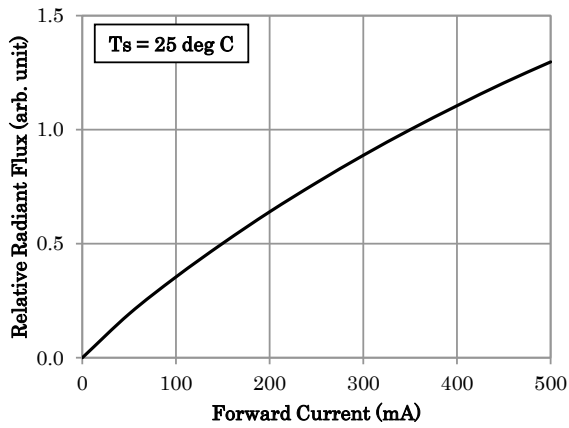

■ Forward Voltage vs Forward Current

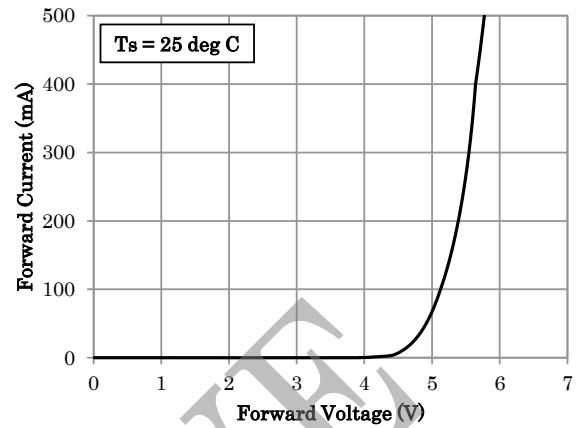

■ Solder Point Temperature vs Relative Radiant Flux

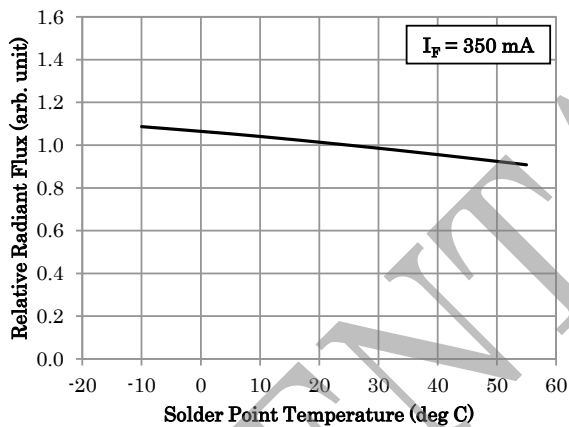

■ Solder Point Temperature vs Forward Voltage

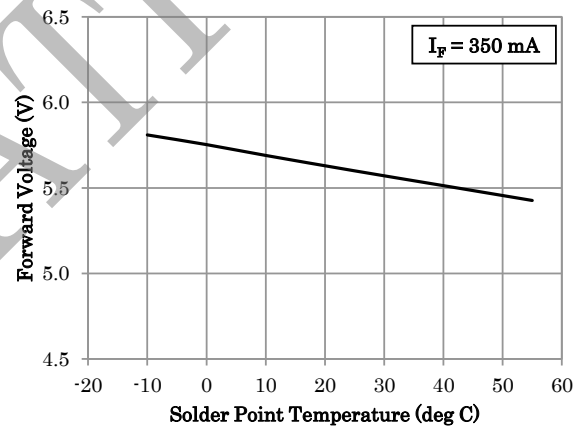

■ Solder Point Temperature vs Peak Wavelength

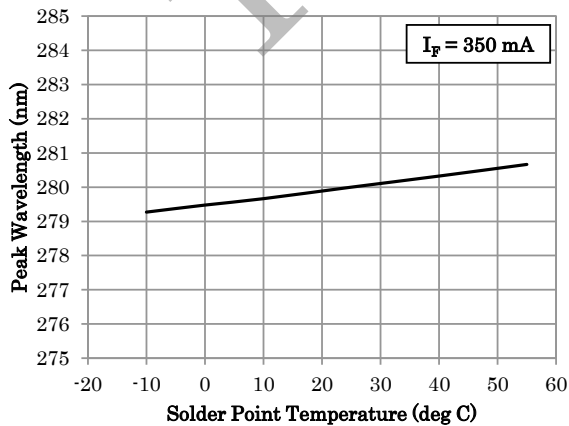

■ Spectrum

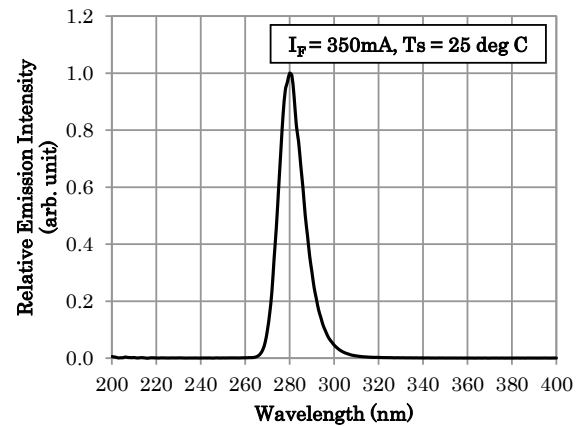

■ Directivity

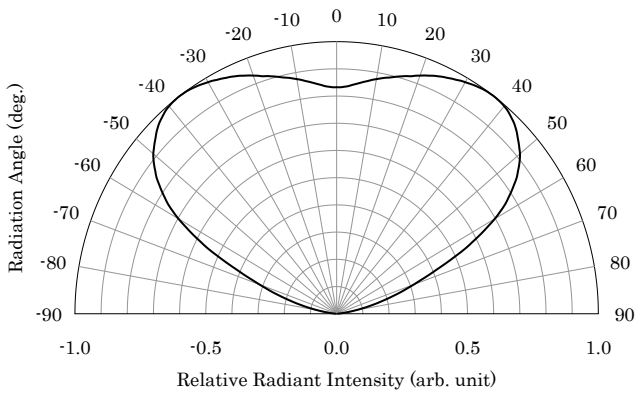

■ Derating Curve

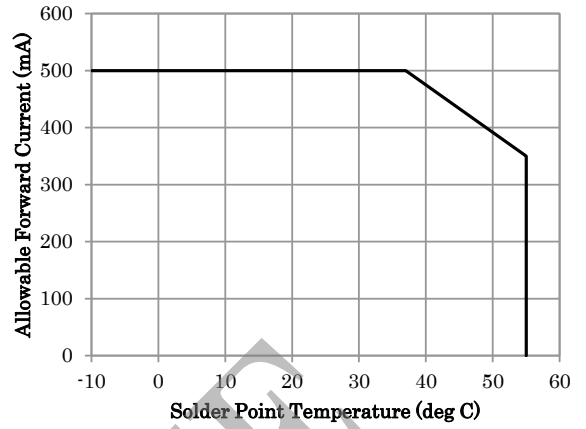

9. Outline Dimensions, Main Materials and Electric Circuit

9.1. Outline Dimensions, Main Materials

Items	Materials
Printed Circuit Board Materials	Cu Base / Black Solder Resist
DUV-LED	Refer to 9.2
Lead-Free Solder	Sn (86 wt%)-Ag (2.7 wt%)-Cu (0.45 wt%)
Connector Materials	BeCu

(Unit: mm, Tolerance: ±0.2)

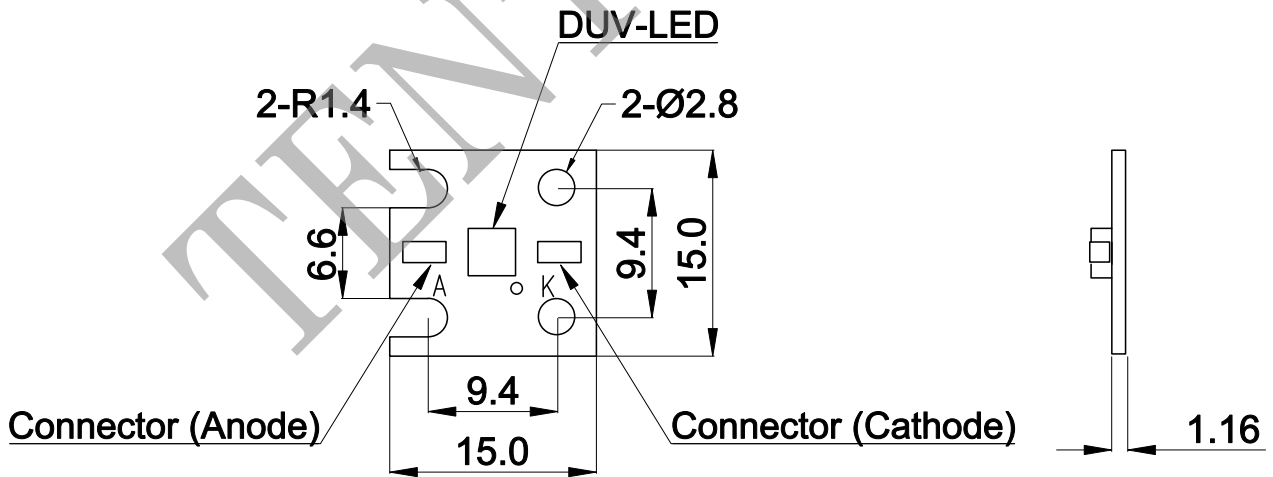

9.2. Outline Dimensions, Main Materials of DUV-LED

Items	Materials
Package Materials	Ceramics
Glass Materials	Synthetic Quartz
Electrodes Materials	Au-plated

(Unit: mm, Tolerance: ± 0.2)

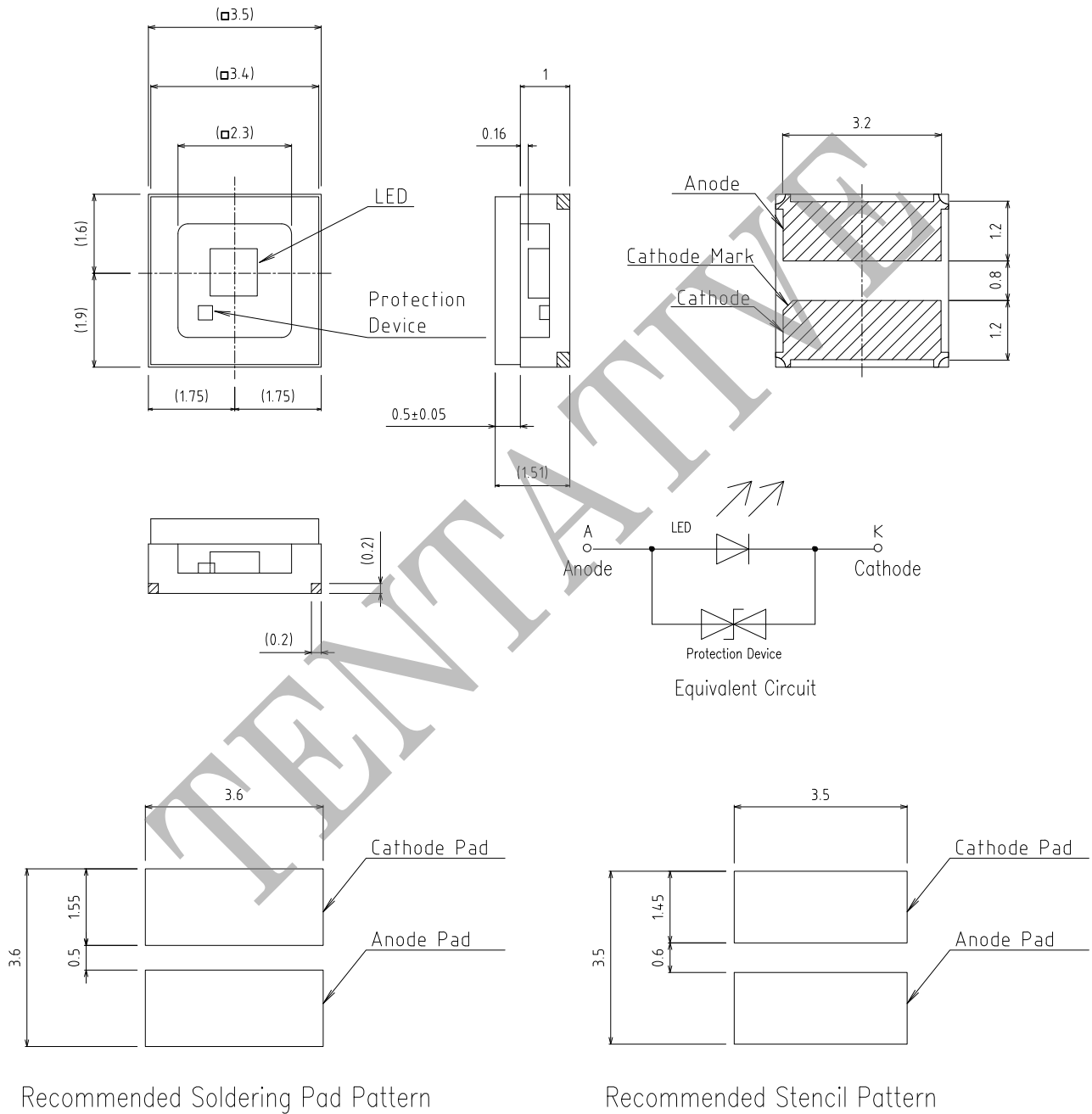

NOTE: This Product should be operated in forward bias.

10. Serial Numbering Code

8-digit serial number is written at the bottom of the product.

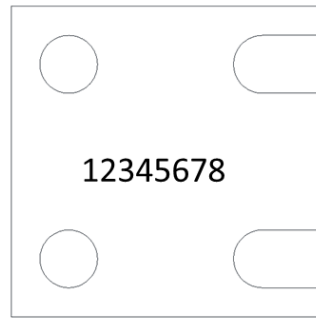

TENTATIVE

11. Packaging

- 1) 10-pocket shipping tray made of anti-static polyethylene foam with a chamfered corner at its upper-left is used for shipment.
- 2) Products are arranged in the left-to-right direction from the upper-left pocket.
- 3) Another anti-static polyethylene foam is used as a tray cover. Shipping tray and tray cover are tied with polyurethane bands.
- 4) Labels are attached to tray cover and vacuum-sealed in moisture-barrier bags.
- 5) Up to 2 bags (20 pcs: 10 pcs x 2) can be packed in a single shipping box.
- 6) Empty void space in the shipping box is filled with shock-absorbing materials.

NOTES: Do not drop or expose the shipping box to external forces.

Read “Cautions” chapter below before removing the tray cover from the tray.

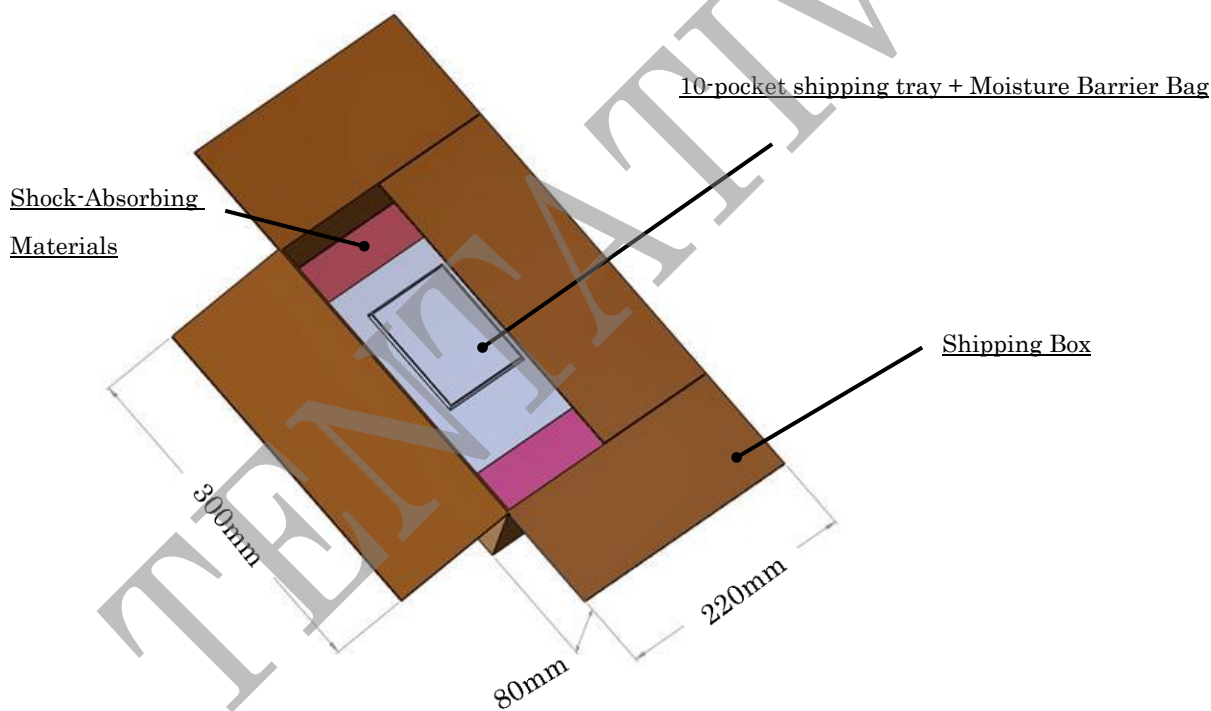

Packaging of Shipping Trays (2 trays max.)

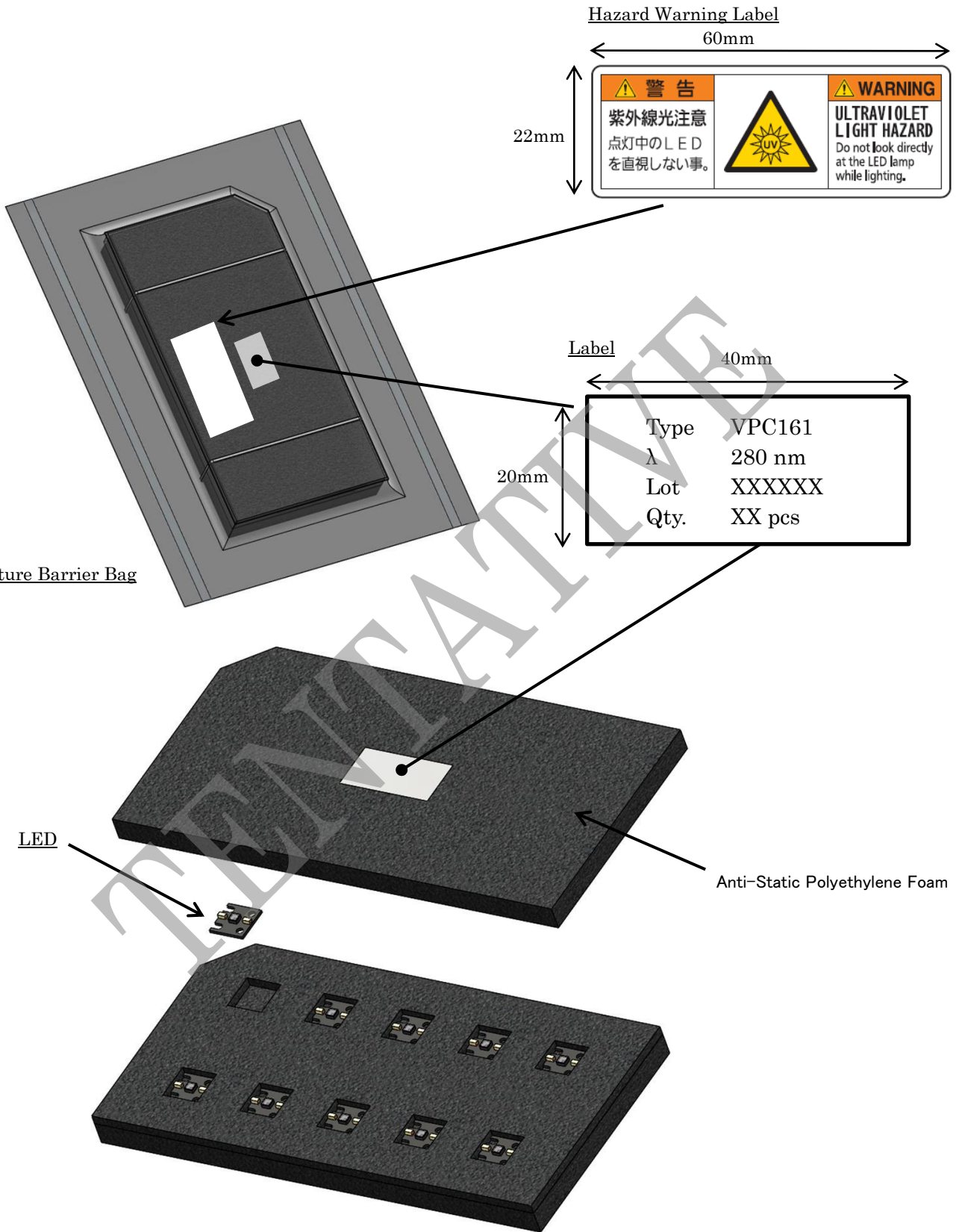

12. Cautions

- (A) The specifications described in this document are subject to change without prior notice.
- (B) Both the customer and Nikkiso will agree on the official specifications of supplied product before the volume production begins.

(C) Transportation

- 1) To avoid water condensation, do not expose the products to large temperature fluctuations.
- 2) Do not expose the cardboard box to water. It is not water-resistant.
- 3) In transportation, packing equivalent to that of our original shipment is recommended, in order to preserve the product quality.
- 4) Do not drop or expose the shipping box to external forces as it may damage the products inside.

(D) Storage

- 1) The recommended storage conditions are as follows:

Storage	Temperature	Humidity	Period
Before opening moisture barrier bag	15 deg C ≤ T ≤ 30 degC	RH ≤ 85 %RH	Within 6 months after arrival date
After opening moisture barrier bag	15 deg C ≤ T ≤ 30 degC	RH ≤ 75 %RH (99 % N2 or Air is recommended)	Within 6 months after arrival date AND within 3 months after opening the bag

- 2) Before using the products expiring the maximum storage period, carry out the sampling test to make sure that the performance of the products from this stock is sufficient for intended application.
- 3) The maximum rating of storage temperature refers to the allowable limit in circumstances where the products are exposed to a high/low temperature for a short period of time (in transportation etc.) and does not ensure long-term storage.
- 4) The products can easily drop out of the shipping tray. Be careful when removing the tray cover.
- 5) Do not remove the tray cover when the shipping tray is upside down. The products will drop out. If that happens, we cannot guarantee the product quality.
- 6) Storage conditions that exceed the recommended storage conditions may affect the characteristics of the products.
- 7) Exposure to corrosive atmosphere may change the surface state of the Cu board or connectors. Carefully control the storage conditions.
- 8) Do not store the products in a dusty environment.
- 9) Do not expose the products to direct sunlight or an environment where the temperature is higher than the normal room temperature for a long period.
- 10) When storing, take care that a load is not applied to the products.

(E) Electrostatic Discharge (ESD)

- 1) Although it contains a built-in ESD protection device, this product is vulnerable to static electricity or surge voltage. Do not handle the products with bare hands and take appropriate measures against electrostatic discharge such as a grounded wrist strap and anti-static gloves.

(F) Thermal Management

- 1) The junction temperature that exceeds the absolute maximum ratings conditions in this document may lead to the failure of this product, even if it happened for a short period of time. Also, this product is not designed to work at the absolute maximum ratings conditions for extended periods, and we do not guarantee the product reliability that is operating at the absolute maximum ratings conditions. The junction temperature is affected by the solder point temperature, which is determined by the PCB's thermal resistance and the ambient temperature. Measure the solder point temperature to ensure that the junction temperature described as below does not exceed the maximum junction temperature.

$$\text{Junction Temperature: } T_j (\text{deg C}) = T_s (\text{deg C}) + I_F (\text{A}) \times V_F (\text{V}) \times R_{J-S} (\text{deg C} / \text{W})$$

Determine the drive current according to the solder point temperature and take appropriate measures for heat dissipation.

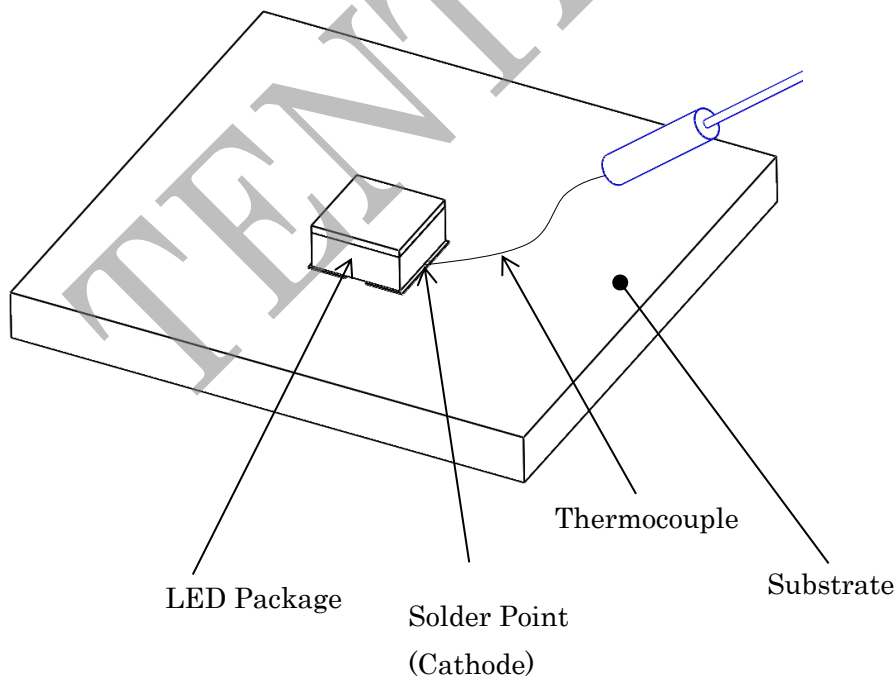

REFERENCE DRAWING: Measurement of Solder Point Temperature

(G) Handling

- 1) Absolute maximum ratings conditions are not the conditions where the product reliability is guaranteed during operation. Operating conditions outside the derating curve may cause the products to degrade, leading to the decreased product reliability. Set the operating conditions so as not to go over the derating curve even for a moment.
- 2) Do not handle the products with bare hands. It will contaminate the product surface and may affect the optical characteristics.
- 3) Do not stack the products together. The impact may cause the products to be scratched, chipped, delaminated and/or deformed, affecting the optical characteristics. In the worst case, it may cause an open circuit and complete failure of the products.
- 4) A vacuum tweezer is recommended for handling of this product. When handling with normal tweezers, do not pick the glass material. Wear safety glasses to prevent damage to the eyes from the chipped or broken glass material.
- 5) Insufficient flux cleaning will leave flux residue, which will absorb moisture during prolonged use and may cause leakage current or corrosion of electrodes.
- 6) Throwing or dropping the shipping box may cause the product inside to be broken.
- 7) Be careful when carrying the product after unboxing. Vibration or impact may cause the detachment and/or crack of glass material.
- 8) To protect the products from the electrostatic charge generated by vibration in transportation, use anti-static bags or cases. Anti-static measures must be taken even for short time/distance transportation.
- 9) The products may be exposed to a tough environment in shipment. Please take appropriate measures against moisture, mechanical impact and vibration, such as moisture barrier bags, hermetic containers and shock-absorbing materials.
- 10) Exposure to water or saltwater may cause a short circuit. The electrodes may also corrode leading to failure of the products.
- 11) Since the product temperature may rise due to the self-heating, do not touch the product during operation or just after shutting down.
- 12) Since the heat from this product may heat up the surrounding objects, heat-resistive materials are recommended to be used in the equipment including this product.
- 13) When using several LEDs at the same time, design the circuit so that each LED will not operate with a condition over the absolute maximum ratings. It is recommended that each LED be operated with constant current.
- 14) This product also emits visible light, which may be a hindrance for certain applications. Make sure before the usage that this does not cause a problem.
- 15) When operating the product outdoors, carefully carry out the operation verification tests considering the climatic shift at the point of use.

- 16) Do not wipe the product as the glass material could fall off.
- 17) Do not use ultrasonic cleaning.
- 18) Do not apply reverse voltage to the product.
- 19) Remove foreign objects and substances from the surface of the product and the installation site.
- 20) Apply heat-conductive grease or sheet on the back surface of the product.
- 21) Proper screw torque for the installation of this product is 20 cN·m.
- 22) Vibration may cause the unplugging or breaking of the cable. Carefully choose the installation site.

(H) Ultraviolet (UV)

- 1) Do not look directly into the operating deep-ultraviolet LED as it may cause damage to the eyes. If looking into the operating LED is necessary, be sure to wear ultraviolet light protective glasses.
- 2) IEC62471 “Photobiological Safety of Lamps and Lamp Systems” defines exposure limits of electromagnetic radiation in the wavelength range from 200 nm to 3000 nm for each possible hazard (to the skin, eye, and retina). The deep ultraviolet light emitted from this product can be classified as belonging to the following hazards. It is recommended to understand the content of the standard before using the product.

Relevant Hazards

- Hazard to the skin
 - 4.3.1Es Actinic UV hazard exposure limit for the skin and eye
- Hazard to the eye (cornea)
 - 4.3.1Es Actinic UV hazard exposure limit for the skin and eye
 - 4.3.2Euva Near-UV hazard exposure limit for the eye
- Hazard to the retina
 - 4.3.3Lb Retina blue light hazard exposure limit
 - 4.3.4Eb Retina blue light hazard exposure limit – small source

(I) Others

- 1) This product is intended to be used for a general purpose (industry or consumer equipment). Consult Nikkiso's sales staff in advance for information on more specialized applications in which higher quality is required (power plant application, submarine equipment, space equipment, aircraft equipment, medical equipment, transport equipment, emergency equipment etc.).
- 2) The customer shall not reverse engineer by disassembling or analysis of the LEDs without having prior written consent from Nikkiso. When defective LEDs are found, the customer shall inform Nikkiso directly before disassembling or analysis.

TENTATIVE