

CITILED COB+ Series
DATA SHEET
CLC034-081C1



CONTENTS

1. Introduction	P 2
2. Performance Characteristics	P 3
3. Mechanical Dimensions	P 5
4. Characteristic Curves	P 6
5. Reliability	P 9
6. Packing Specification	P 10
7. Precaution	P 11
8. Warranty	P 14
9. Action for failed product	P 14
10. Others	P 14
11. Use of this product	P 15

CITIZEN ELECTRONICS CO., LTD.

1-23-1, Kamikurechi, Fujiyoshida-shi, Yamanashi, 403-0001, Japan Tel. +81-555-23-4121 <http://ce.citizen.co.jp>
Copyright © 2010 CITIZEN ELECTRONICS CO., LTD. All Rights reserved.

Product Nomenclature



CLC034 - 081 C1 - 31 3 H3 H3 - 185
 [1] [2] [3] [4] [5] [6]

[1]	Product shape	CLC034
[2]	Die count	81
[3]	Cool CCT	3100K
[4]	Chromaticity range	MacAdam 3step *1
[5]	CRI (Ra)	Min.90
[6]	Warm CCT	1850K

1. Introduction

1-1. Product Description

This product (COB) is comprised of two different CCTs, and is to be driven using the 2 terminals which are shown in Page 5.

1-2. Features

- Mechanical Dimensions : 19.0 x 26.0 x 1.6 (mm)
- Package Structure : Ceramic Base Chip on Board
- Ceramic Base: : material AZ214T(Certificate Number 20140905-E356524)
- Connection to Heat Sink : By Holder + M3screw, Thermally conductive glue
- CRI (Ra) : Min.90
- Cool CCT : 3,100K (IF=550mA)
- Warm CCT : 1,850K (IF=10mA)
- Chromaticity Range : 3-step MacAdam Ellipse, the center refers to ANSI C78.377:2011. *1
- Thermal Resistance : 2.0C/W
- RoHS compliant

*1 It applies only to cool CCT.

2. Performance Characteristics

2-1. Electro Optical Characteristics

(Tc=25C)

Product cord	Nominal CCT	CRI (Ra)		Luminous flux (lm)			Chromaticity		Forward Current (mA)	Voltage (V)			Thermal Resistance Rj-c (C/W)
		Ra	R9	Min.	Typ.	Max.	x	y		Min.	Typ.	Max.	
		Min	Min				Typ	Typ					
CLC034-081C1-313H3H3-185	3100K	90	50	2,000	2,300	-	0.430	0.402	550.0	32.9	35.8	38.7	2.0
	1850K	90	50	13	24	-	0.544	0.410	10.0	24.6	26.7	28.8	2.0

Notes :

1. The tolerance of measurement at our tester is forward voltage +/-3%, Φ_V +/-10% , Chromaticity(x,y)+/-0.005 and Ra+/-1.

2-2. Absolute Maximum Ratings

Parameter	Symbol	Rating	
Input Power [W]	Pi	27.8	*1
Forward Current [mA]	IF	720.0	*1
Minimum Current [mA]	IF min	8	
Reverse Current [mA]	Ir	1	
Operating Temperature [C]	Top	-30 ~ +85	
Storage Temperature [C]	Tst	-40 ~ +100	
Case Temperature [C]	Tc	85	*2
Junction Temperature [C]	Tj	150	*3

*1. Input power and forward current are the values when the LED is used within the range of the derating characteristics in this data sheet.

*2 Refer to 3. Mechanical Dimensions for Tc measurement point

*3 $T_j = T_c + R_{j-c} \times P_i$

2-3. Chromaticity Characteristics

(Tc=25C)

Color Region	Nominal CCT	Center Point (x, y)	Oval parameter		
			Major Axis a	Minor Axis b	Ellipse Rotation Angle θ
3-step MacAdam ellipse	3100K	(0.4301, 0.4016)	0.00834	0.00408	53.17
5-step MacAdam ellipse	1850K	(0.5436, 0.4098)	0.0129	0.00685	57.28

* Color region stays within MacAdam 3-step ellipse from the chromaticity center.

* θ is the angle between the major axis of the ellipse and the x-axis, and a and b are the major and minor semi-axes of an ellipse.

(Ref. IEC 60081:1997 AnnexD)

Color region

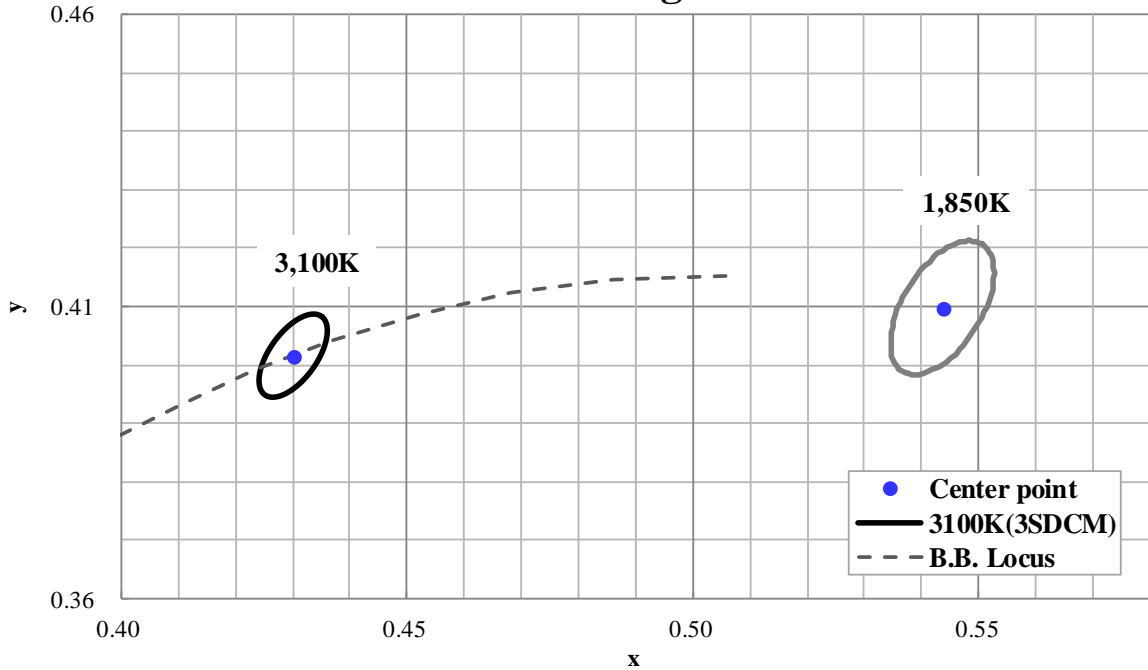

3. Mechanical Dimensions

Unit : mm

Tolerances unless otherwise specified : +/-0.3

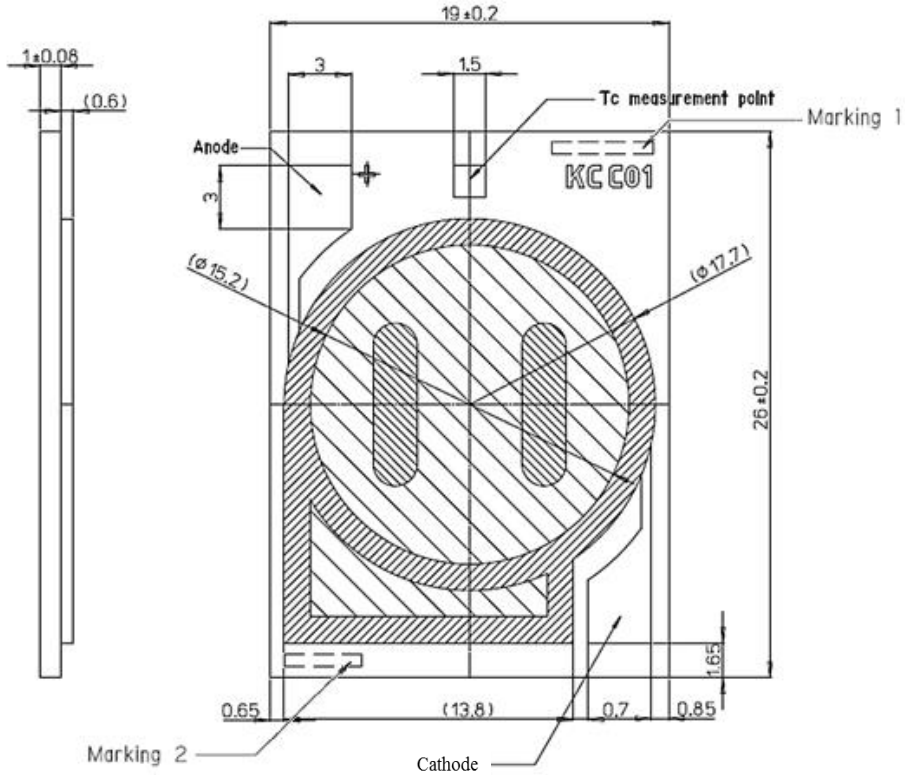

Marking 1 : Serial No.

Marking 2 : *** ** * **

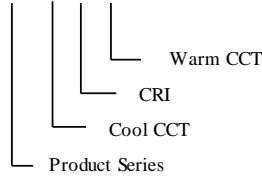

Circuit diagram

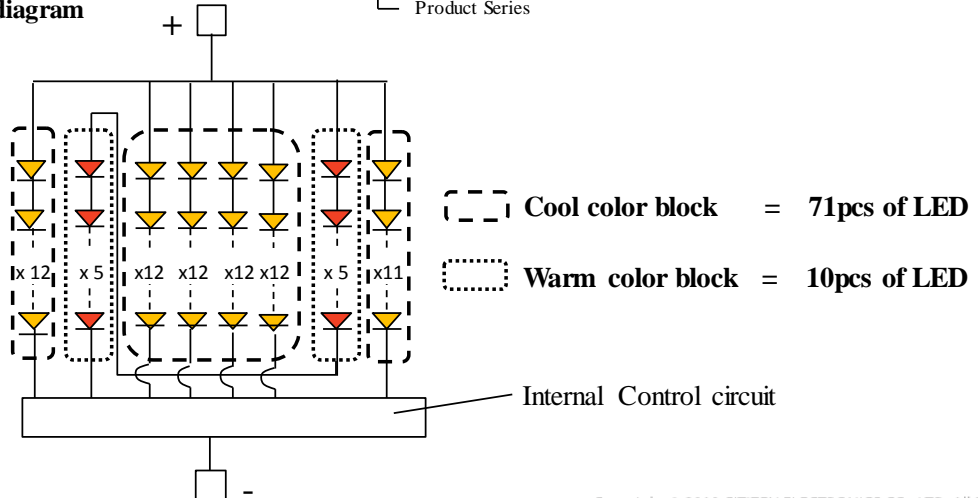

Copyright © 2010 CITIZEN ELECTRONICS CO., LTD. All Rights reserved.

4. Characteristic Curves

4-1. Forward Current Characteristics / Temperature Characteristics

Forward Current vs. Forward Voltage

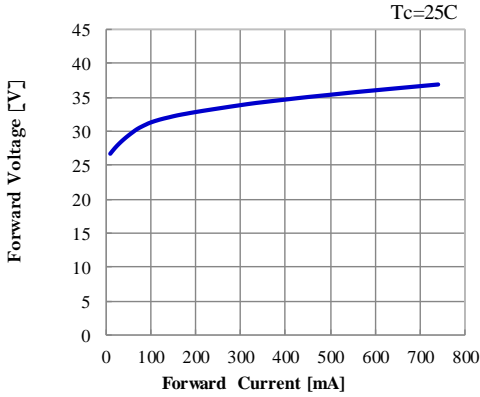

Forward Current vs. Relative Luminous Flux

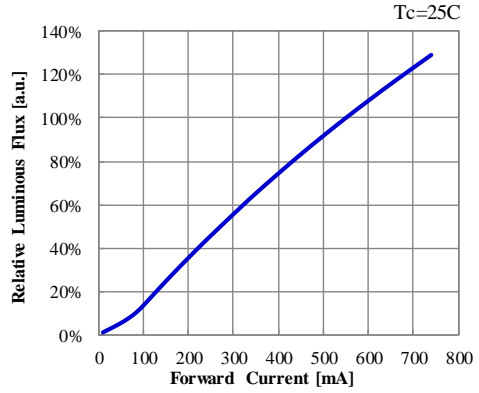

Forward Current vs. CCT

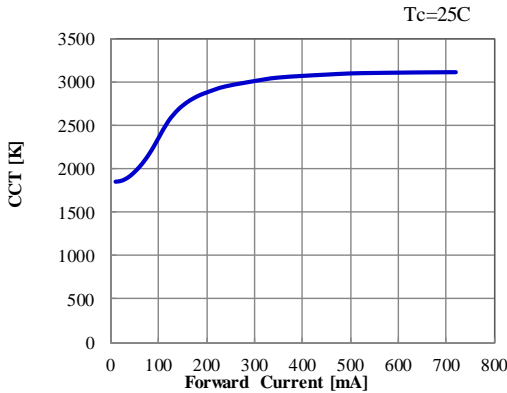

xy Chromaticity profile

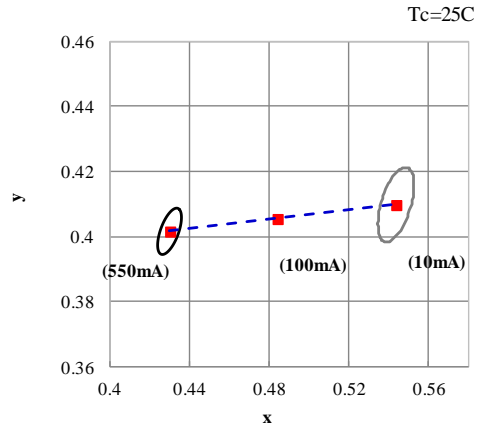

Case Temperature vs. Relative Forward Voltage

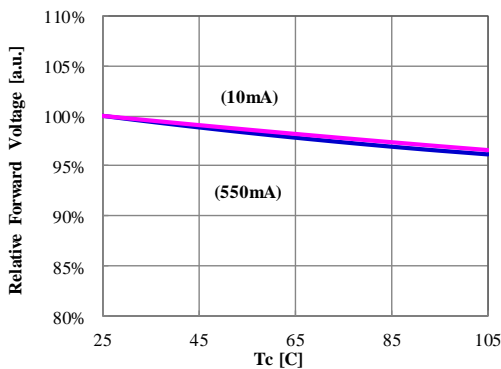

Case Temperature vs. Relative Luminous Flux

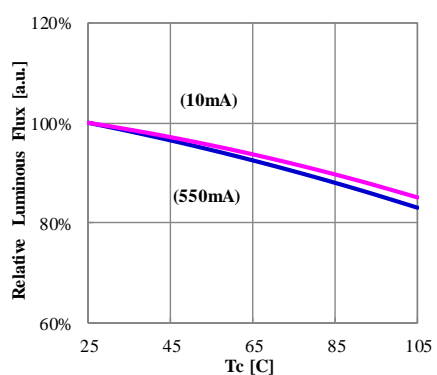

* Characteristics data shown here are for reference purpose only. (Not guaranteed data)

4-2. Optical Characteristics

Spectrum

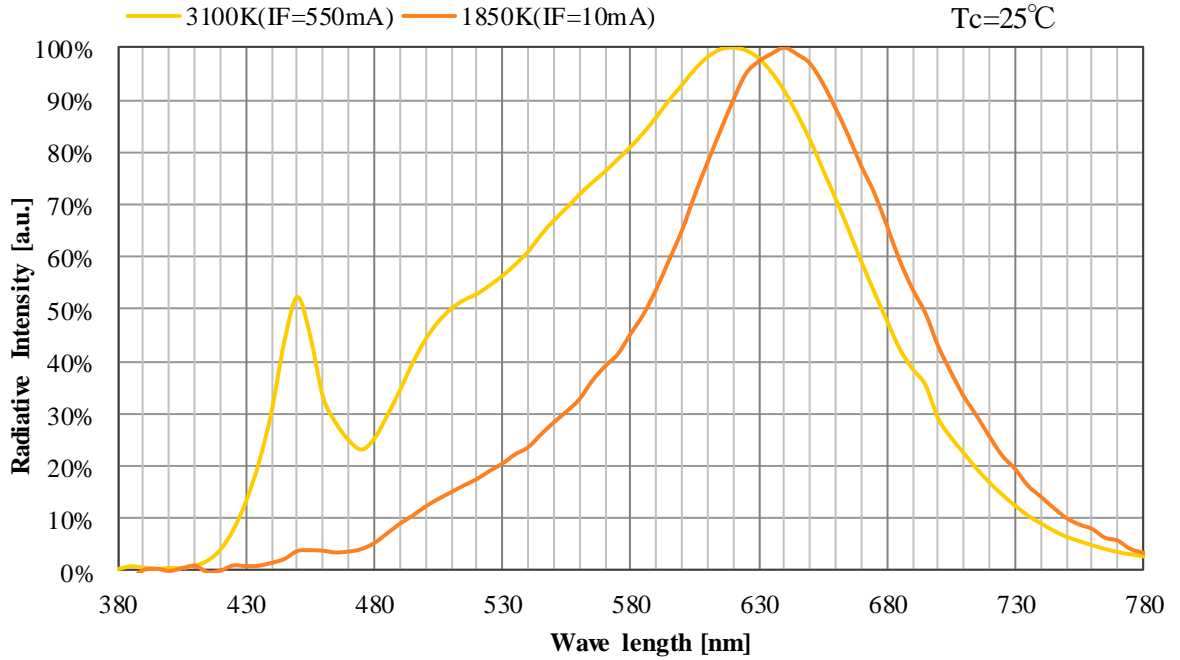

Radiation Characteristic

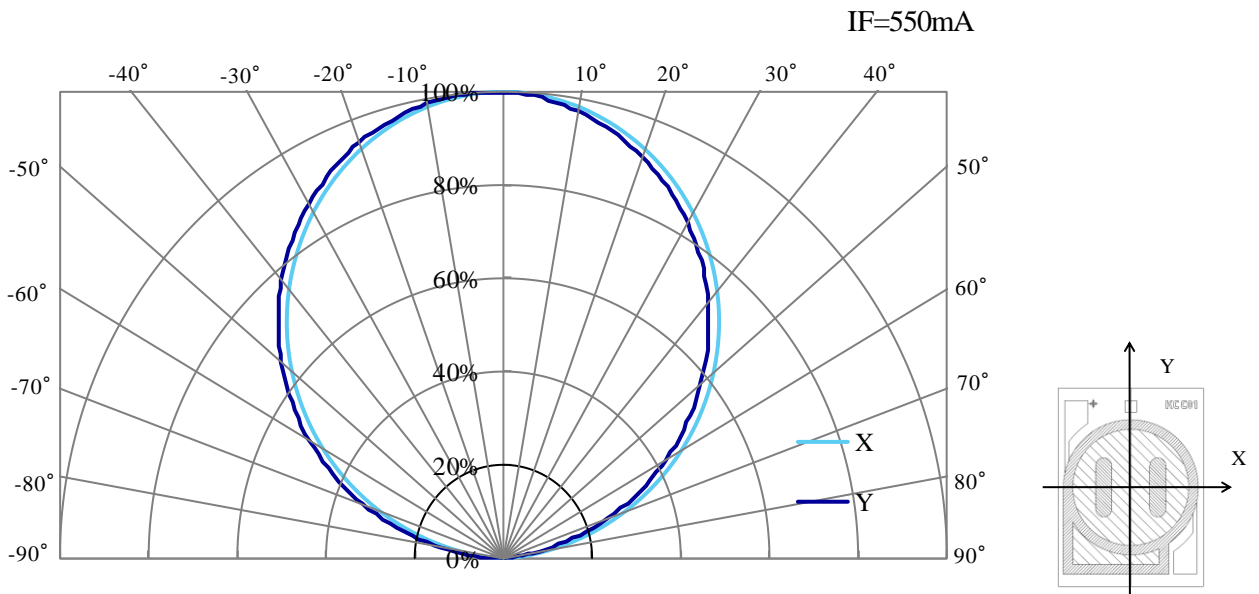

4-2. Optical Characteristics (continued)

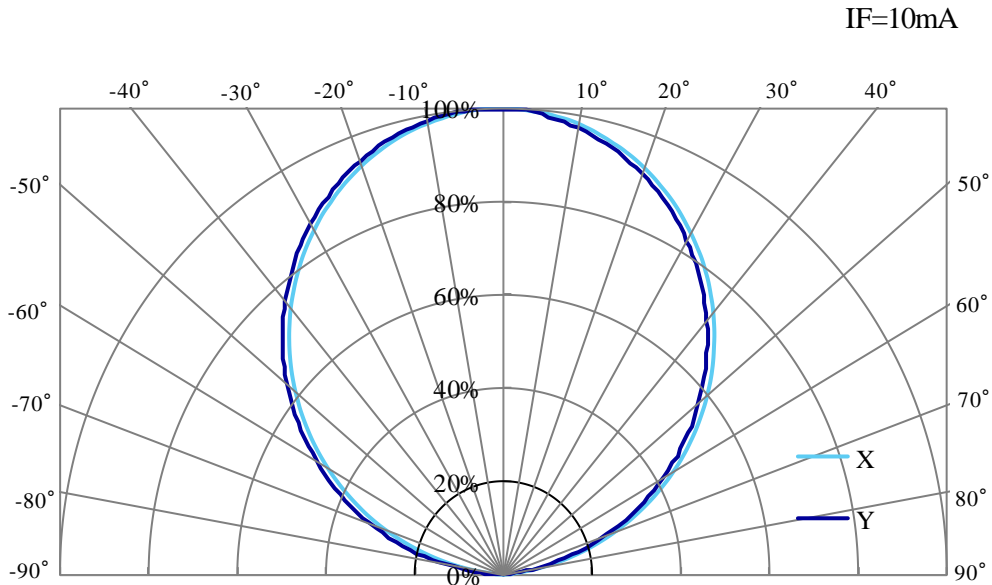

4-3. Derating Characteristics

Case Temperature vs. Allowable Forward Current

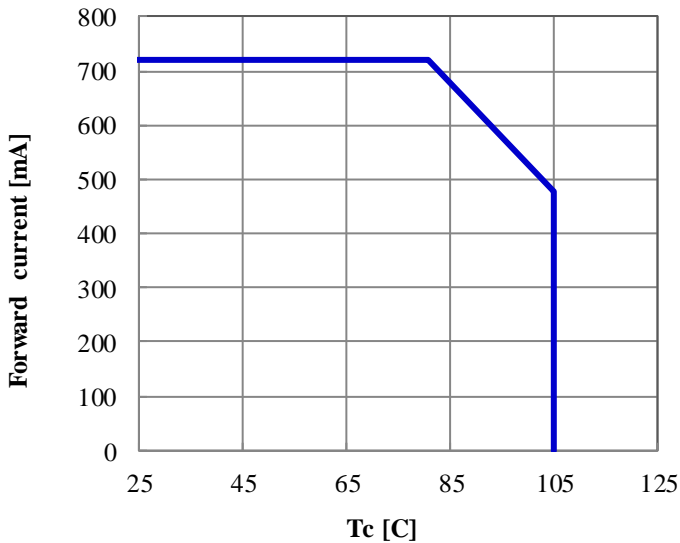

5. Reliability

5-1. Reliability Test

Test Item	Test Condition
Continuous Operation Test	IF =550mA , Tc=85C
Low Temperature Storage Test	Ta = -40 C × 1000 hours
High Temperature Storage Test	Ta = 100 C × 1000 hours
Moisture-proof Test	Tc=85C, 95 %RH for 500 hours
Thermal Shock Test	-30 C × 30 minutes – 85 C × 30 minutes, 100 cycle

5-2. Failure Criteria

(Tc=25C)

Measuring Item	Symbol	Measuring Condition	Failure Criteria
Power Dissipation	VF	IF =550mA	>U × 1.2
Total Luminous Flux	Φv	IF =550mA	<S × 0.8

U defines the upper limit of the specified characteristics. S defines the initial value.

Note : Measurement shall be taken between 2 hours and 24 hours, and the test pieces should be return to the normal ambient conditions after the completion of each test.

6. Packing Specification

6-1. Packing

An empty tray is placed on top of a 6-tier tray which contain 40 pieces each.
(Smallest packing unit: 240 pieces)

A label with product name, quantity and lot number is placed on the upper empty tray.

Tray (Dimensions: 310 x 210 x 12 mm / Materials: Electrically conductive PS)

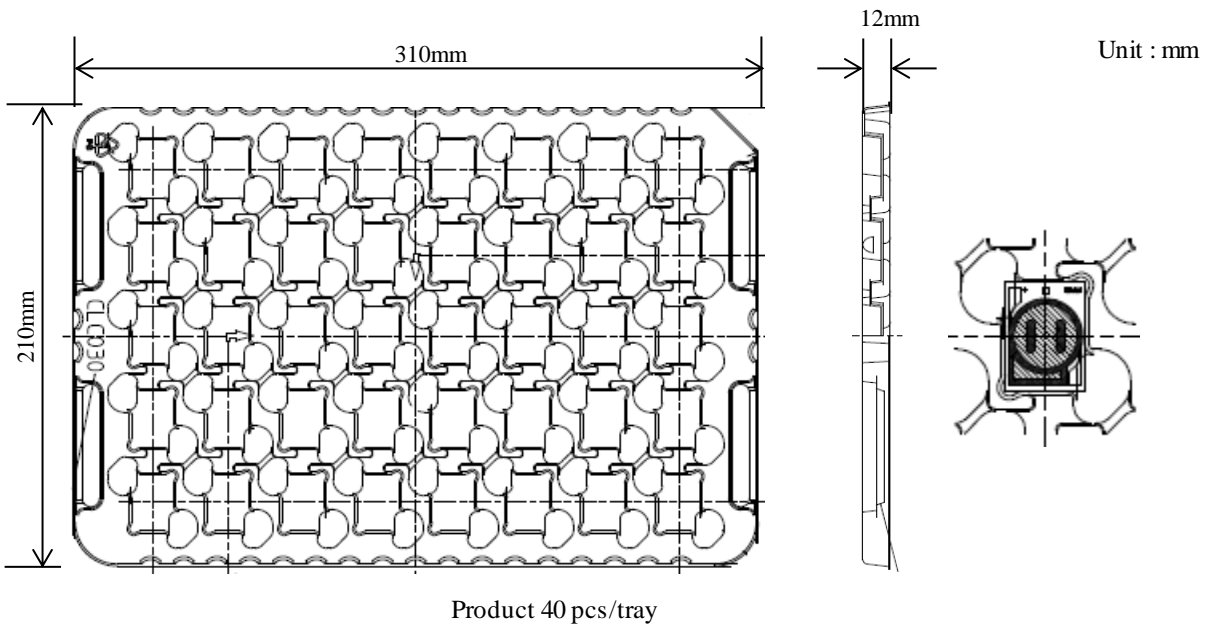

Example of indication label

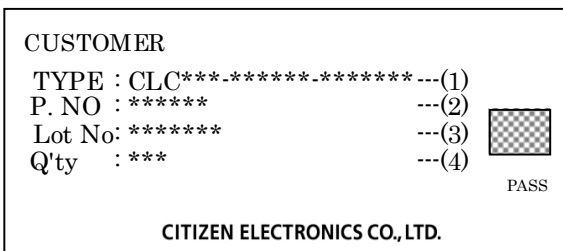

1. TYPE e.g. CLC034-081C1-313H3H3-185
2. P.No. (Customer's P/N)
3. Lot No.
 - First and second letter: Last digit of the year e.g. 15 : year 2015
 - Third letter: Production month e.g. 1 : January
 - Note: October, November and December are designated X,Y and Z.
 - Forth letter: CE's control number e.g. 5035
4. Quantity

7. Precaution

7-1. Handling with care for this product

- Both the light emitting area and white dam over the light emitting area is composed of resin materials. Please avoid the resin area from being pressed, stressed, rubbed, come into contact with sharp metal nail (e.g. edge of reflector part) because the function, performance and reliability of this product are negatively impacted.
- Please be aware that this product should not come into contact with any other parts while incorporating in your lighting apparatus or your other products.

7-2. Countermeasure against static electricity

- Handling of this product needs countermeasures against static electricity because this is a semiconductor product.
- Please take adequate measures to prevent any static electricity being produced such as the wearing of a wristband or anti-static gloves when handling this product.
- Every manufacturing facility in regard to the product (plant, equipment, machine, carrier machine and conveyance unit) should be connected to ground and please avoid the product to be electric-charged.

7-3. Caution of product assembly

- Regarding this product assembling on the heat sink, it is recommended to use thermal conductivity glue or grease, and please optimize the assembly conditions according to the specifications of the thermal conductivity glue or grease. Please don't fix this product on Heat sink by screw directly to prevent breaking ceramic substrate. In addition, please don't press with excess stress on the product while the assembly. And, the surfaces of thermal conductivity glue or grease, should be kept clean, therefore please remove pollution, fluid and oil on the surfaces.
- Roughness, unevenness and burr of surface negatively impact thermal bonding between the product and heat sink and increase heat thermal resistance between them. Confidence of thermally and mechanical coupling between the product and heat sink might be confirmed by checking the mounting surface and measuring the case temperature of the product.
- Heat sink should be covered under the yellow resin area locating on the side of center light emitting area because it generates heat as same as emitting area.

7-4. Thermal Design

- The thermal design to draw heat away from the LED junction is most critical parameter for an LED illumination system. High operating temperatures at the LED junction adversely affect the performance of LED's light output and lifetime. Therefore the LED junction temperature should not exceed the absolute maximum rating in LED illumination system.
- The LED junction temperature while operation of LED illumination system depends upon thermal resistance of internal LED package (Rj-c), outer thermal resistances of LED package, power loss and ambient temperature. Please take both of the thermal design specifications and ambient temperature conditions into consideration for the setting of driving conditions.
- For more information, please refer to application note "Thermal Management".

7-5. Driving Current

- A constant current is required as an applying driving current to this product.
- Electrical transient might apply excess voltage, excess current and reverse voltage to the product(s). They also affect negative impact on the product(s) therefore please make sure that no excess voltage, excess current and reverse voltage is applied to the product(s) .
- Please verify that the selected driver and dimmer switch can drive CLC034 correctly.

7-6. Electrical Safety

- This product itself is designed to cover UL requirements that may apply on the final product. however, the UL certification still needs to be granted as the final product level which is depending on the design structure, materials used and how the LED is placed and fixed in the final product. Therefore please confirm electrical safety and dielectric in final product.
- Component failures can be caused by excessive voltage.
- Discharge before handling this product.
- ESD sensitivity of this product is over 1000V (based on IEC61000-4-2).

7-7. Recommended soldering Condition (This product is not adaptable to reflow process.)

-For manual soldering

Please use lead-free soldering. Soldering shall be implemented using a soldering bit at a temperature lower than 380C, and shall be finished within 5 seconds for one land.

No external force shall be applied to resin part while soldering is implemented.

Next process of soldering should be carried out after the product has return to ambient temperature.

-For soldering correction

Regarding soldering correction, above conditions shall be applied.

Contacts number of soldering bit should be within twice for each terminal as a correction.

* Citizen Electronics cannot guarantee if usage exceeds these recommended conditions.

Please use it after sufficient verification is carried out on your own risk if absolutely necessary.

7-8. Eye Safety

-The International Electrical Commission (IEC) published in 2006 IEC 62471 "2006 Photobiological safety of lamps and lamp systems " which includes LEDs within its scope.

When sorting single LEDs according to IEC 62471, almost all white LEDs can be classified as belonging to either Exempt Group (no hazard) or Risk Group 1 (low risk).

-However, Optical characteristics of LEDs such as radiant flux, spectrum and light distribution are factors that affect the risk group determination of the LED, and especially a high-power LED, that emits light containing blue wavelengths, might have properties equivalent to those of Risk Group 2 (moderate risk).

-Great care should be taken when directly viewing an LED that is driven at high current, has multiple uses as a module or when focusing the light with optical instruments, as these actions might greatly increase the hazard to your eyes.

-It is recommended to regard the evaluation of stand-alone LED packages as a reference and to evaluate your final product.

7-9. This product is not designed for usage under the following conditions.

If the product might be used under the following conditions, you shall evaluate its effect and appropriate them. In places where the product might:

-directly and indirectly get wet due to rain and/or at place with the fear.

-be damaged by seawater and/or at place with the fear

-be exposed to corrosive gas (such as Cl₂, H₂S, NH₃, SO_x, NO_x and so on) and/or at place with the fear.

-be exposed to dust, fluid or oil and/or at place with the fear.

-be put in the enclosed space with halogenated substance and/or gas (such as Br, Cl and so on).

8. Warranty

- (1) CITIZEN ELECTRONICS guarantees the term of the reliability test results and elementary substances of the supplies to be within the set conditions.
Please note that any accident/damage that occurs during or because of usage that deviates from the conditions contained in the specifications are not warrantable.
- (2) Although CITIZEN ELECTRONICS will deliver products of quality assured by the terms included in these specifications, incorporation in actual machines, lifetime in actual use and another quality shall be confirmed sufficiently by customers.
Customers are responsible for ensuring quality and to meet the specifications such as with regard to the security / the performance to standards of safety / reliability of the finished product.
- (3) The use of this product is intended for use in general electronics such as business machines, communication equipment, audio-visual equipment, household electrical appliances and measurement devices, etc.
- (4) If this product is considered to be used in applications where high reliability is required and failure or malfunction have a direct influence on human life or health such as aerospace instrument, medical equipment, atomic energy control devices and so on, please contact Citizen Electronics beforehand.

9. Action for failed product

- (1) If a failed product is found, action shall be taken after consultation between both sides.
However, in cases where it is obvious that the relevant failed product is attributed to CITIZEN ELECTRONICS, action will be limited to product replacement delivery.
- (2) When a failed product is returned, the failure phenomenon should be specified in writing and attached.
CITIZEN ELECTRONICS will review the condition promptly and report the result to the customer.

10. Others

- (1) All matters of this product's quality with regard to the customer are mentioned in these specifications, and any matters which are not mentioned in these specifications in items stated prior to receipt shall lose efficacy.
- (2) When a question occurs about the contents of these specifications, please contact CITIZEN ELECTRONICS.
In addition, if there is any discrepancy in the contents of these specifications, both sides shall handle the matter with gentlemanlike discussion.
- (3) Please do not conduct any actions equal to reverse-engineering such as the disassembling or the analysis of this product without CITIZEN's permission.
Please contact CITIZEN directly without disassembling in any way if a failure is found in this product.
- (4) If this product is not returned within three weeks after this specification has been published, it is judged that the contents have been accepted.

CITIZEN Micro HumanTech is a registered trademark of Citizen Holding Co., Japan.
CITILED is a registered trademark of CITIZEN ELECTRONICS CO., LTD. Japan

11. Use of this product

(1) This document is provided for reference purposes only so that CITIZEN ELECTRONICS' products are used as intended. CITIZEN ELECTRONICS neither makes warranties or representations with respect to the accuracy or completeness of the information contained in this document nor grants any license to any intellectual property rights or any other rights of CITIZEN ELECTRONICS or any third party with respect to the information in this document.

(2) All information included in this document such as product data, diagrams, charts, is current as of the date this document is issued.

Such information, however, is subject to change without any prior notice.

Before purchasing or using any CITIZEN ELECTRONICS' products listed in this document, please confirm the latest product information with a CITIZEN ELECTRONICS' sales office, and formal specifications must be exchanged and signed by both parties prior to mass production.

(3) CITIZEN ELECTRONICS has used reasonable care in compiling the information included in this document, but CITIZEN ELECTRONICS assumes no liability whatsoever for any damages incurred as a result of errors or omissions in the information included in this document.

(4) Absent a written signed agreement, except as provided in the relevant terms and conditions of sale for product, and to the maximum extent allowable by law, CITIZEN ELECTRONICS assumes no liability whatsoever, including without limitation, indirect, consequential, special, or incidental damages or loss, including without limitation, loss of profits, loss of opportunities, business interruption and loss of data, and disclaims any and all express or implied warranties and conditions related to sale, use of product, or information, including warranties or conditions of merchantability, fitness for a particular purpose, accuracy of information, or no infringement.

(5) Though CITIZEN ELECTRONICS works continually to improve products' quality and reliability, products can malfunction or fail. Customers are responsible for complying with safety standards and for providing adequate designs and safeguards to minimize risk and avoid situations in which a malfunction or failure of a product could cause loss of human life, bodily injury or damage to property, including data loss or corruption.

In addition, customers are also responsible for determining the appropriateness of use of any information contained in this document such as application cases not only with evaluating by their own but also by the entire system.

CITIZEN ELECTRONICS assumes no liability for customers' product design or applications.

(6) Please contact CITIZEN ELECTRONICS' sales office if you have any questions regarding the information contained in this document, or if you have any other inquiries.

CITIZEN Micro HumanTech is a registered trademark of Citizen Holding Co., Japan.

CITILED is a registered trademark of CITIZEN ELECTRONICS CO., LTD. Japan

- CITIZEN ELECTRONICS CO., LTD. shall not be liable for any disadvantages or damages resulting from the use of technical information or data included in this document or the impossibility of download and use, responsibility for the cause of lawsuit or any other damages or losses.
- This technical information or data shall be provided 'as is' to users and CITIZEN ELECTRONICS CO., LTD. does not guarantee the absence of error or other defects in this technical information or data, conformance of this technical information or data to specific purpose, this technical information or data or its use will not infringe the rights of users or third parties or any other content.
- CITIZEN ELECTRONICS CO., LTD. reserves the right to make changes to technical information or data without notification.

Information contained in this document such as sentences, photographs and images is subject to copyright, and is protected by law. Unless it is for "duplication for private use" or "quotation" under copyright law, any duplication or diversion of this information without permission of CITIZEN ELECTRONICS CO., LTD. is prohibited by law.

CITIZEN and **CITIZEN** are trademarks or registered trademarks of CITIZEN HOLDINGS CO., LTD. JAPAN.
CITILED is a trademark or a registered trademark of CITIZEN ELECTRONICS CO., LTD. JAPAN.



CITIZEN ELECTRONICS CO., LTD.

1-23-1, Kamikurechi, Fujiyoshida-shi, Yamanashi, 403-0001, Japan
Tel. +81-555-23-4121
<http://ce.citizen.co.jp>

Requests / Inquiries

inquiry@ce.citizen.co.jp

Website for LEDs for lighting

http://ce.citizen.co.jp/lighting_led/jp/