

## Product Specification

Product Code: VPS171

Product	Surface Mount Type UV-LED 285 nm
Title	Product Specification
Document No.	NKSUV-AD01-0035
Version	2.1
Issue Date	May. 8, 2017

NIKKISO GIKEN Co., Ltd.

NKSUV-AD01-0035

# Table of Contents

	Page
1. Product Description .....	3
2. Intended Use .....	3
3. Product Code .....	3
4. Absolute Maximum Ratings.....	3
5. Electrical and Optical Characteristics .....	3
6. Environmental Compliance.....	3
7. Electrostatic Discharge (ESD) Protection.....	3
8. Reference Data and Derating Curve .....	4
9. Outline Dimensions, Main Materials and Electric Circuit.....	6
10. Recommended Reflow Soldering Condition (Lead-Free Solder).....	7
11. Serial Numbering Code .....	8
12. Packaging .....	9
13. Cautions.....	11

1. Product Description: Surface mount type, high-power deep-ultraviolet light emitting diode
2. Intended Use: Deep-ultraviolet light source.  
Caution: This product can only be used as a deep-ultraviolet light source.

3. Product Code

Peak Wavelength	Product Code
285 nm	VPS171

4. Absolute Maximum Ratings

Parameter	Symbol	Unit	Absolute Maximum Ratings	Remark
Forward Current	$I_F$	mA	500	$T_s = 25 \text{ deg C}$
Operating Temperature	$T_{opr}$	deg C	-10 to 55	-
Storage Temperature	$T_{stg}$	deg C	-30 to 85	-
Junction Temperature	$T_j$	deg C	100	-

$T_s$ : Temperature at solder point

5. Electrical and Optical Characteristics ( $I_F = 350 \text{ mA}$ ,  $T_s = 25 \text{ deg C}$ )

Parameter	Symbol	Unit	Min.	Typ.	Max.	Remark
Forward Voltage	$V_F$	V	4.5	6.0	7.0	-
Peak Wavelength	$\lambda_P$	nm	280	285	290	-
Radiant Flux	$P_O$	mW	25	30	-	-
Spectrum Half Width (FWHM)	$\Delta\lambda$	nm	-	13	20	-
Viewing Angle	$2\theta_{1/2}$	deg.	-	130	-	-
Thermal Resistance	$R_{J.s}$	deg C / W	-	15	18	-

6. Environmental Compliance

This product is RoHS and REACH compliant.

7. Electrostatic Discharge (ESD) Protection

ESD protection device is built in this product.

ESD Protection Voltage Level:  $\pm 2.0 \text{ kV}$  (HBM,  $1.5 \text{ k}\Omega$ ,  $100 \text{ pF}$ )

## 8. Reference Data and Derating Curve

Note: All characteristics shown in this section are for reference only and are not guaranteed.

### ■ Forward Current vs Relative Radiant Flux

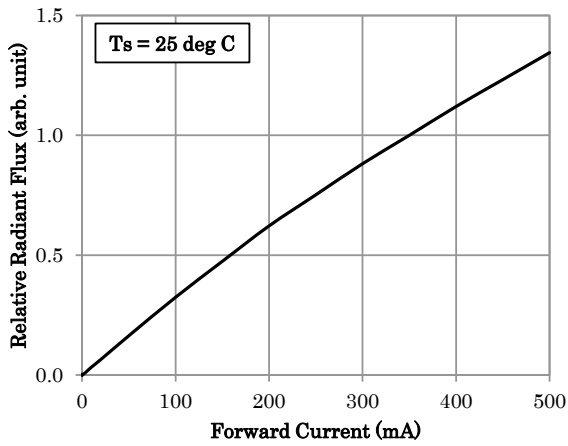

### ■ Forward Voltage vs Forward Current

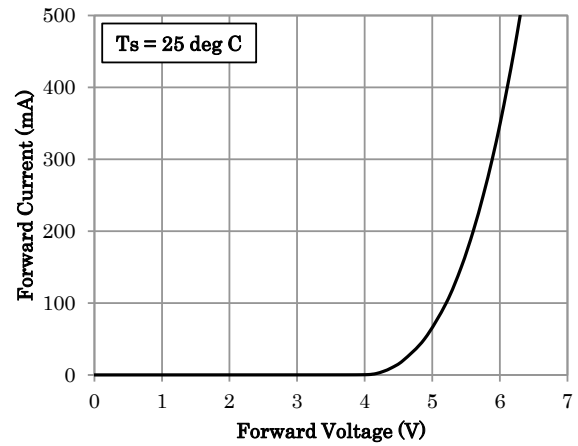

### ■ Solder Point Temperature vs Relative Radiant Flux

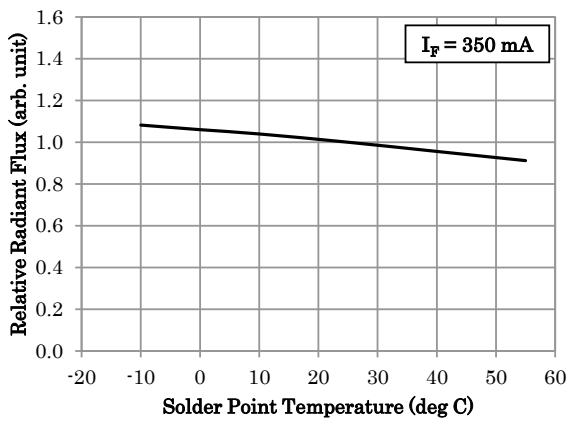

### ■ Solder Point Temperature vs Forward Voltage

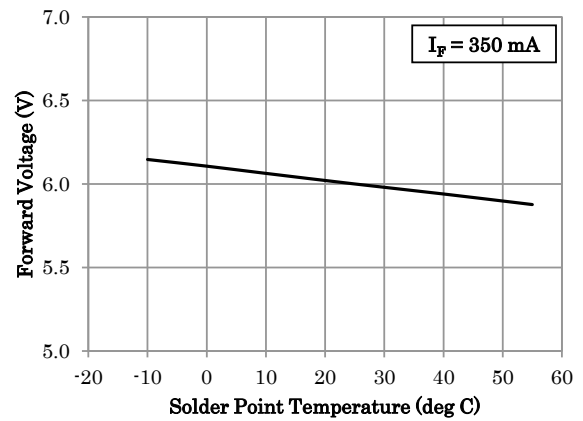

### ■ Solder Point Temperature vs Peak Wavelength

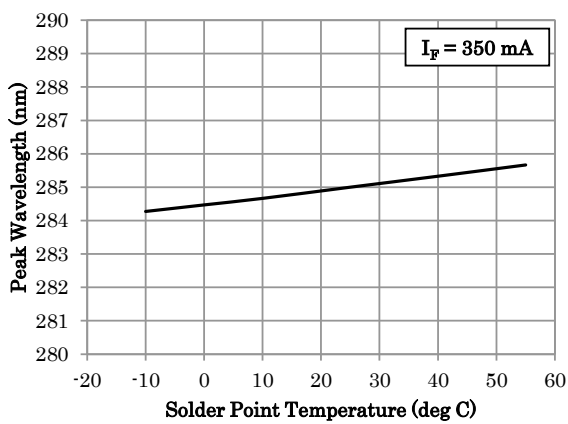

### ■ Spectrum

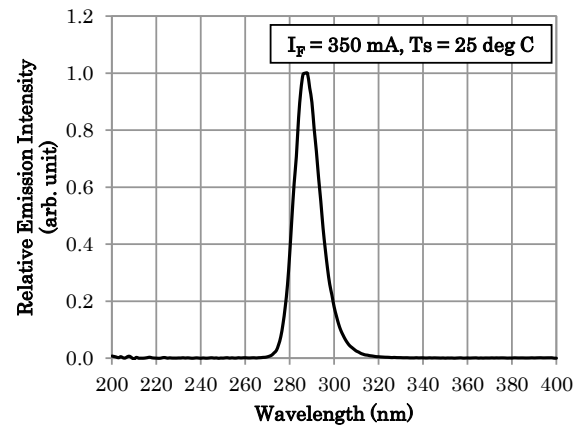

■ Directivity

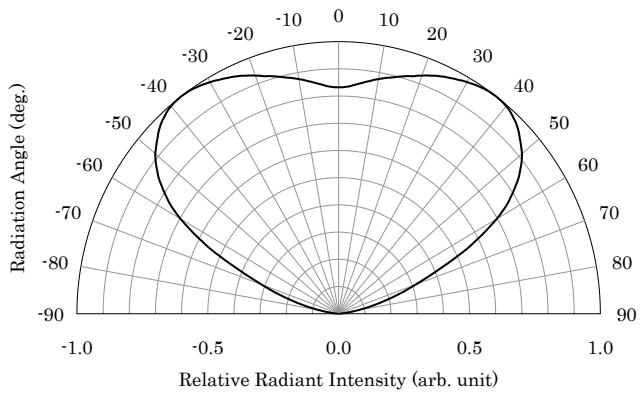

■ Derating Curve

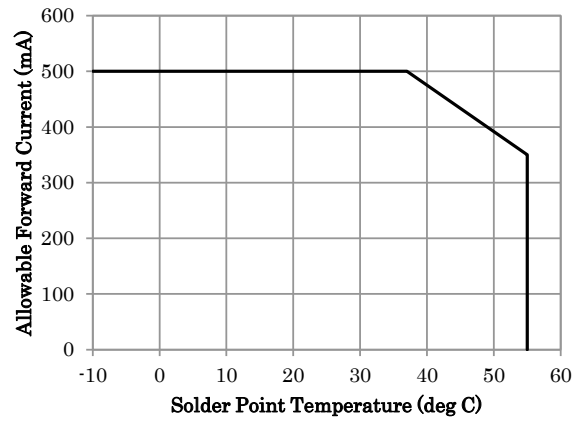

9. Outline Dimensions, Main Materials and Electric Circuit

Items	Materials
Package Materials	Ceramics
Glass Materials	Synthetic Quartz
Electrodes Materials	Au-plated

(Unit: mm, Tolerance:  $\pm 0.2$ )

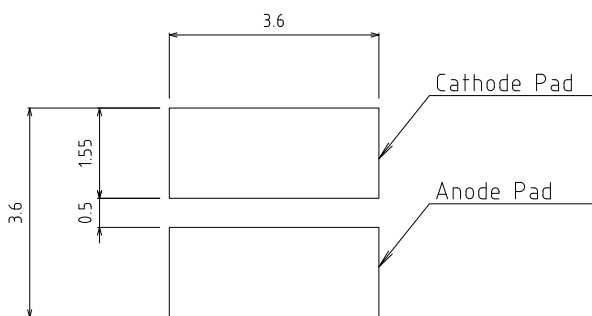
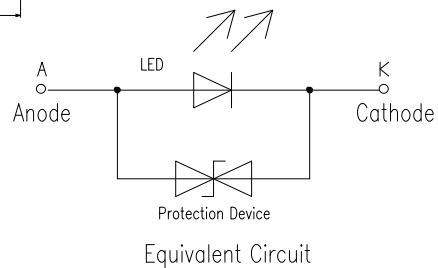
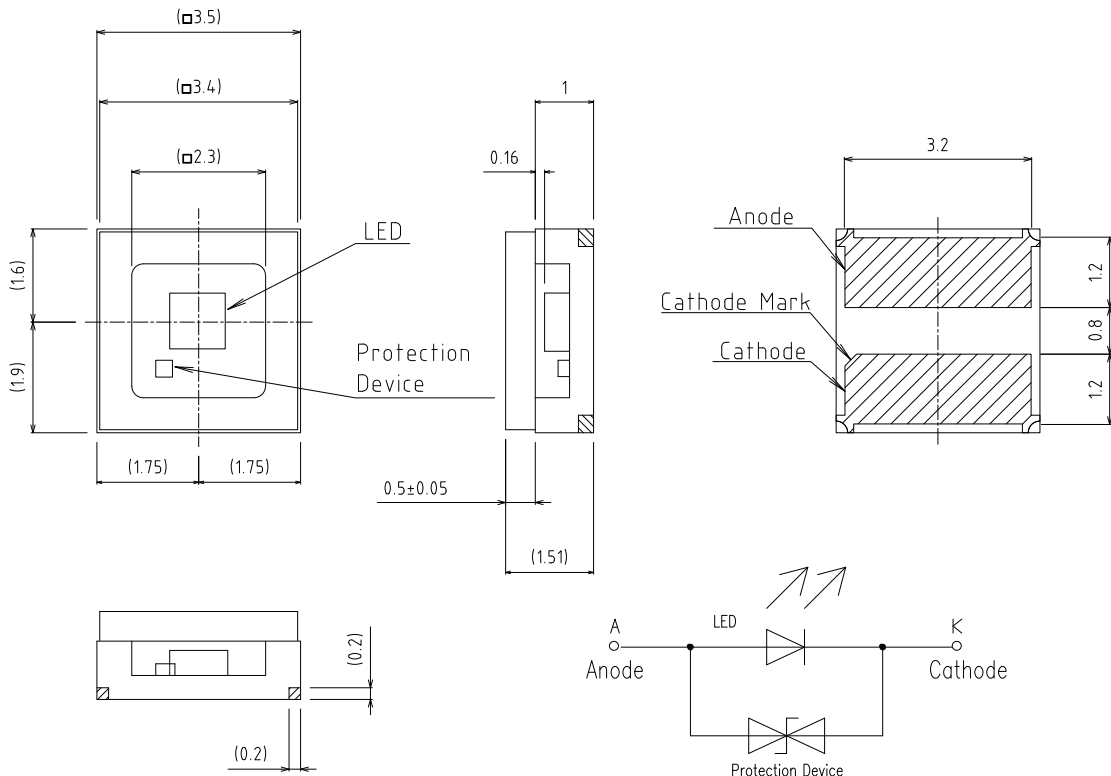

Recommended Soldering Pad Pattern

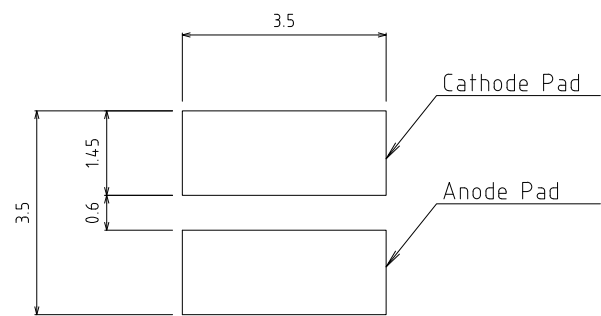

Recommended Stencil Pattern

**NOTE:** This Product should be operated in forward bias.

## 10. Recommended Reflow Soldering Condition (Lead-Free Solder)

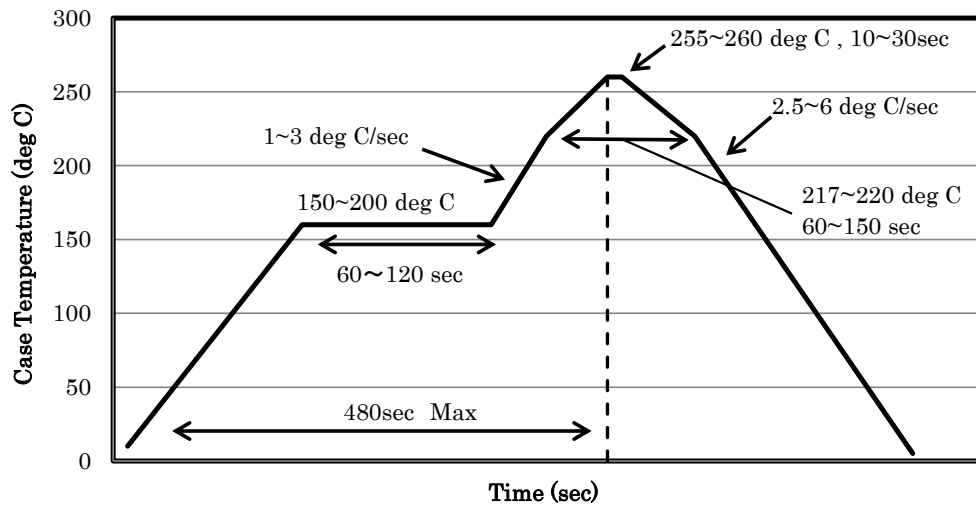

### NOTES:

- 1) REFLOW SOLDERING ONLY. This product is not applicable to flow or hand soldering.
- 2) Do not rework by melting the solder again.
- 3) Allowable Reflow Cycles : 2
- 4) When the products are handled by surface mounters, the suction collet and suction force should be adjusted appropriately in order to avoid mechanical stress on the product.
- 5) Carefully control the ramp-up rate of the reflow process. When using reflow soldering equipment that heats the whole product, temperature difference between the solder point and the product surface may occur. If the heating is too rapid, non-uniform temperature rise and non-uniform thermal expansion may cause damage to the product.
- 6) The peak temperature shown in the figure is the maximum and must not be exceeded.
- 7) Inappropriate soldering operation may result in insufficient solder connection.
- 8) Excessive amount of solder paste causes much more mechanical stress, which may lead to the detachment of the glass material and/or solder crack. Be sure to confirm the proper amount of solder paste.
- 9) Insufficient amount of solder causes less bonding strength, which may lead to the detachment of the product from the board.
- 10) Be sure that the storage time and conditions after opening the moisture barrier bag are within the range specified in "Cautions" chapter below.
- 11) Carefully make sure that the products can be properly soldered before using the products expiring the maximum storage period.
- 12) Avoid rapid cooling from the peak temperature.
- 13) Halogen free solder flux is recommended. Make sure to prevent the contamination of the product's glass material.

- 14) Nitrogen reflow soldering is recommended.
- 15) Use grounded soldering equipment.

11. Serial Numbering Code

Each product is identified by the serial number engraved at the bottom of the product.

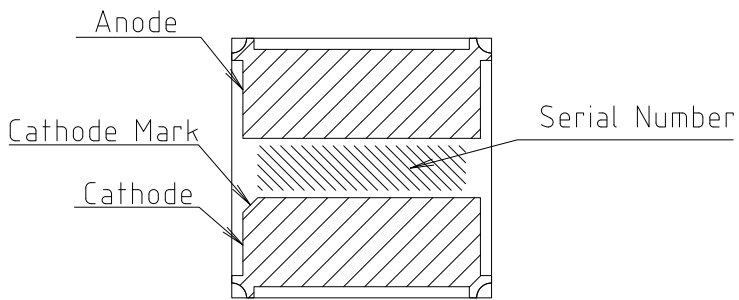
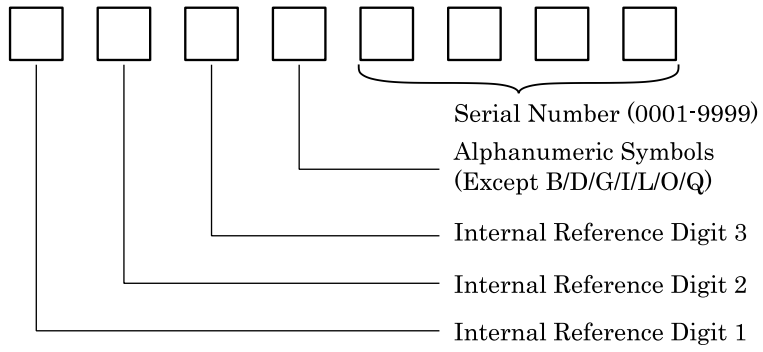



## 12. Packaging

- 1) 100-pocket shipping tray with a chamfered corner at its upper-left is used for shipment.
- 2) Products are arranged in the left-to-right direction from the upper-left pocket.
- 3) Shipping trays and tray covers are tied with polyurethane bands.
- 4) Trays are separately placed in aluminum moisture barrier bags and vacuum-sealed.
- 5) Up to 10 shipping trays (1000 pcs: 100 pcs × 10) can be packed in a single shipping box.
- 6) Empty void space in the shipping box is filled with shock-absorbing materials.

NOTES: Do not drop or expose the shipping box to external forces.

Read “Cautions” chapter below before removing the tray cover from the tray.

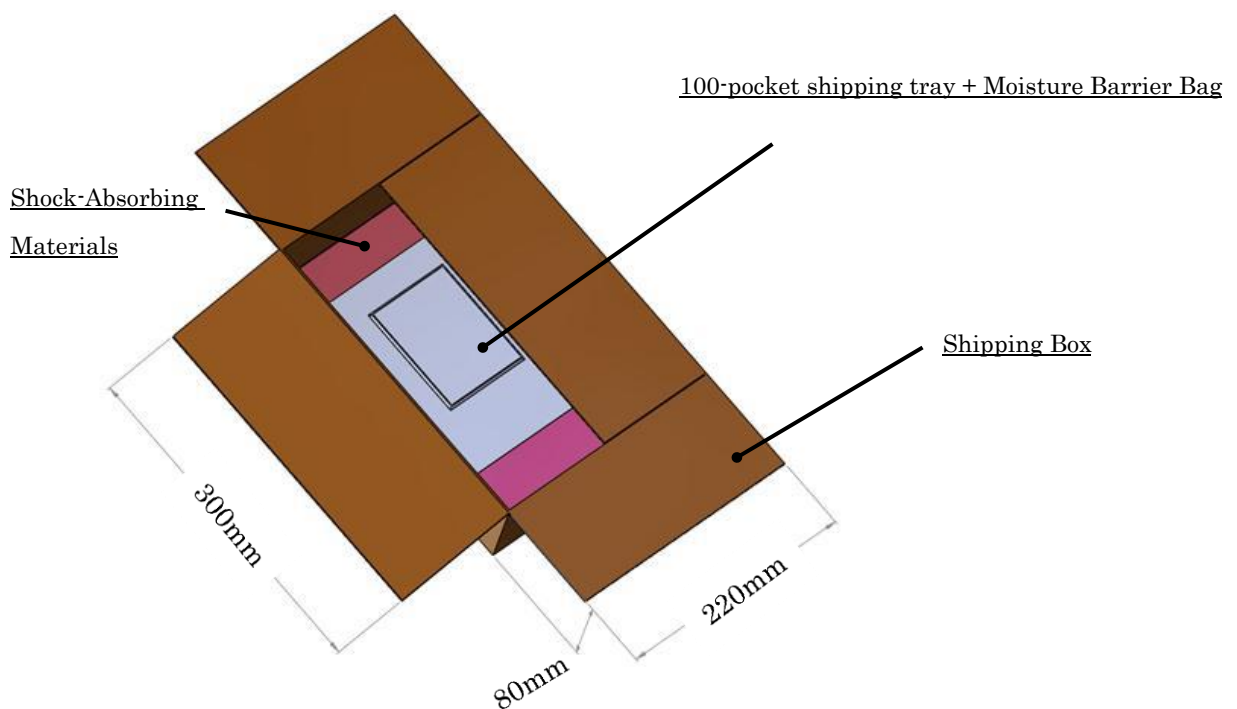

Packaging of Shipping Trays (10 trays max.)

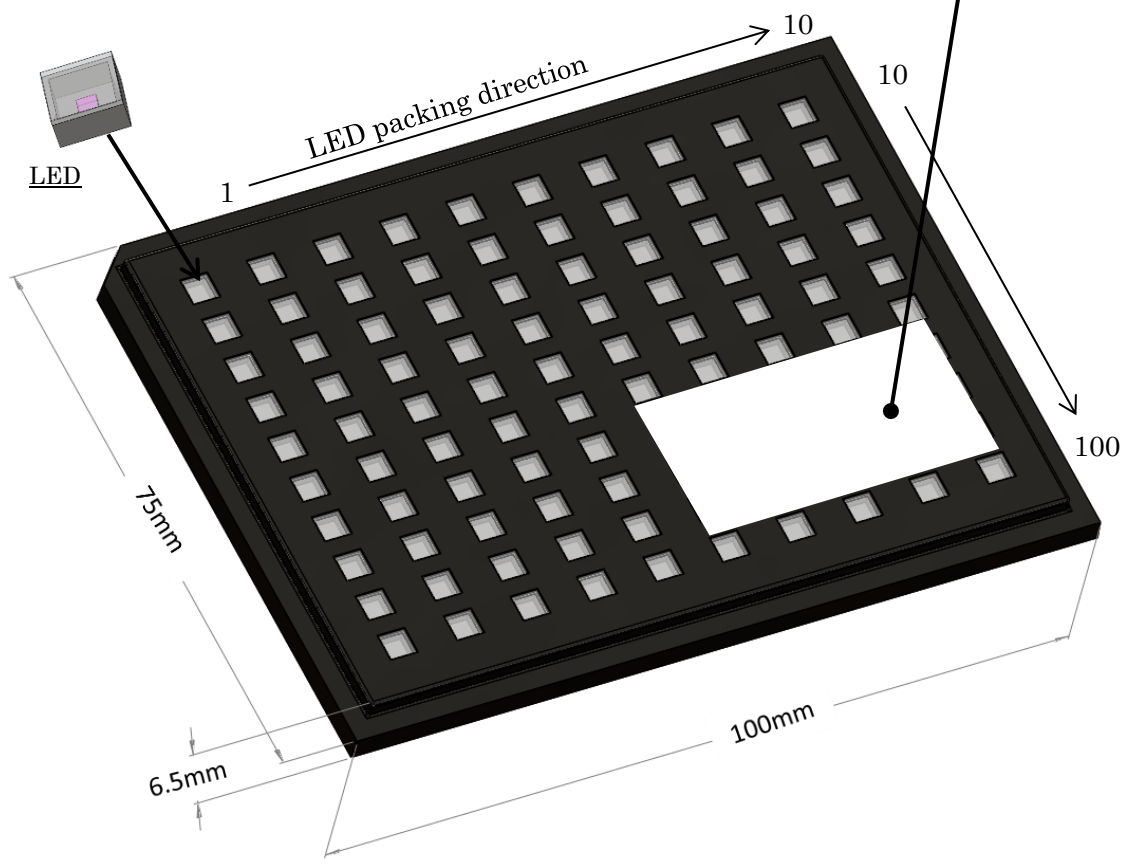
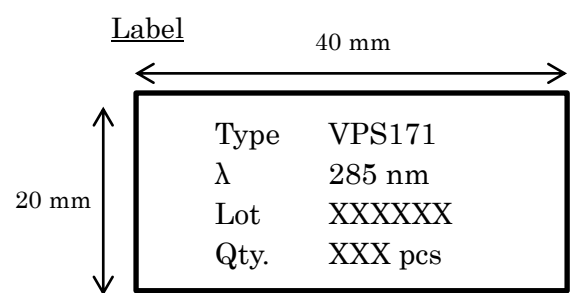
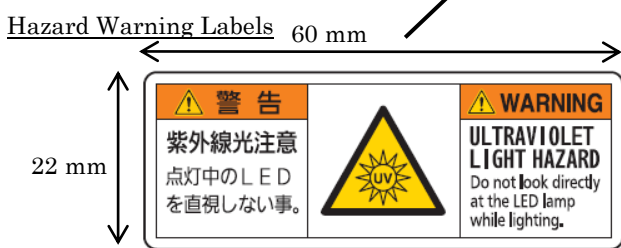
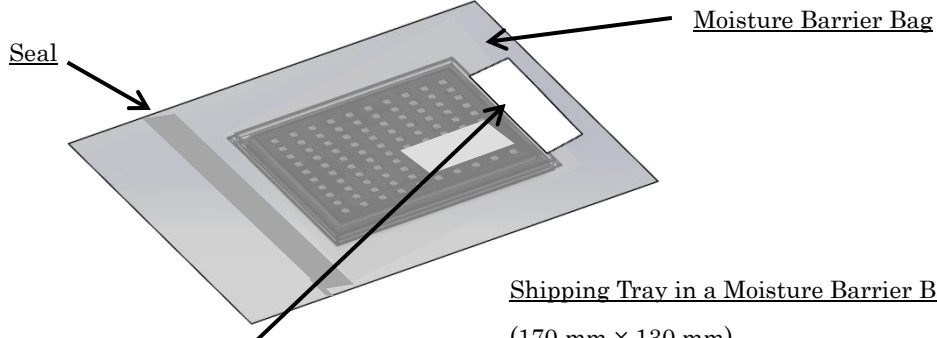

13. Cautions

- (A) The specifications described in this document are subject to change without prior notice.
- (B) Both the customer and Nikkiso will agree on the official specifications of supplied product before the volume production begins.

(C) Transportation

- 1) To avoid water condensation, do not expose the products to large temperature fluctuations.
- 2) Do not expose the cardboard box to water. It is not water-resistant.
- 3) In transportation, packing equivalent to that of our original shipment is recommended, in order to preserve the product quality.
- 4) Do not drop or expose the shipping box to external forces as it may damage the products inside.

(D) Storage

- 1) This product is classified as Moisture Sensitivity Level 1 (MSL 1). For the details of MSL, please refer to the standard JEDEC J-STD-020.
- 2) The recommended storage conditions are as follows:

Storage	Temperature	Humidity	Period
Before opening moisture barrier bag	15 deg C ≤ T ≤ 30 degC	RH ≤ 85 %RH	Within 6 months after arrival date
After opening moisture barrier bag	15 deg C ≤ T ≤ 30 degC	RH ≤ 75 %RH (99 % N2 or Air is recommended)	Within 6 months after arrival date AND within 3 months after opening the bag

- 3) In a hot and humid environment that exceeds the conditions described above, the electrodes may be oxidized and have difficulties in soldering. The shipping tray may also be damaged.
- 4) Before using the products expiring the maximum storage period, carry out the sampling test to make sure that the solderability and the performance of the products from this stock are sufficient for intended application.
- 5) The maximum rating of storage temperature refers to the allowable limit in circumstances where the products are exposed to a high/low temperature for a short period of time (in transportation etc.) and does not ensure long-term storage. For reflow soldering, refer to "Recommended Reflow Soldering Condition (Lead-Free Solder)" section above and do not exceed the maximum peak temperature.
- 6) The products can easily drop out of the shipping tray. Be careful when removing the tray cover.
- 7) Do not remove the tray cover when the shipping tray is upside down. The products will drop out. If that happens, we cannot guarantee the product quality.
- 8) The products can easily drop out of the shipping tray. Seal the shipping tray with the Nikkiso's original tray cover when storing.

- 9) Storage conditions that exceed the recommended storage conditions may affect the characteristics of the products.
- 10) Exposure to corrosive atmosphere may change the surface state of the electrodes, leading to the bad solderability. Carefully control the storage conditions.
- 11) Do not store the products in a dusty environment.
- 12) Do not expose the products to direct sunlight or an environment where the temperature is higher than the normal room temperature for a long period.
- 13) When storing, take care that a load is not applied to the products.

(E) Electrostatic Discharge (ESD)

- 1) Although it contains a built-in ESD protection device, this product is vulnerable to static electricity or surge voltage. Do not handle the products with bare hands and take appropriate measures against electrostatic discharge such as a grounded wrist strap and anti-static gloves.

(F) Thermal Management

- 1) The junction temperature that exceeds the absolute maximum ratings conditions in this document may lead to the failure of this product, even if it happened for a short period of time. Also, this product is not designed to work at the absolute maximum ratings conditions for extended periods, and we do not guarantee the product reliability that is operating at the absolute maximum ratings conditions. The junction temperature is affected by the solder point temperature, which is determined by the PCB's thermal resistance and the ambient temperature. Measure the solder point temperature to ensure that the junction temperature described as below does not exceed the maximum junction temperature.

$$\text{Junction Temperature: } T_j (\text{deg C}) = T_s (\text{deg C}) + I_F (\text{A}) \times V_F (\text{V}) \times R_{j-s} (\text{deg C} / \text{W})$$

Determine the drive current according to the solder point temperature and take appropriate measures for heat dissipation.

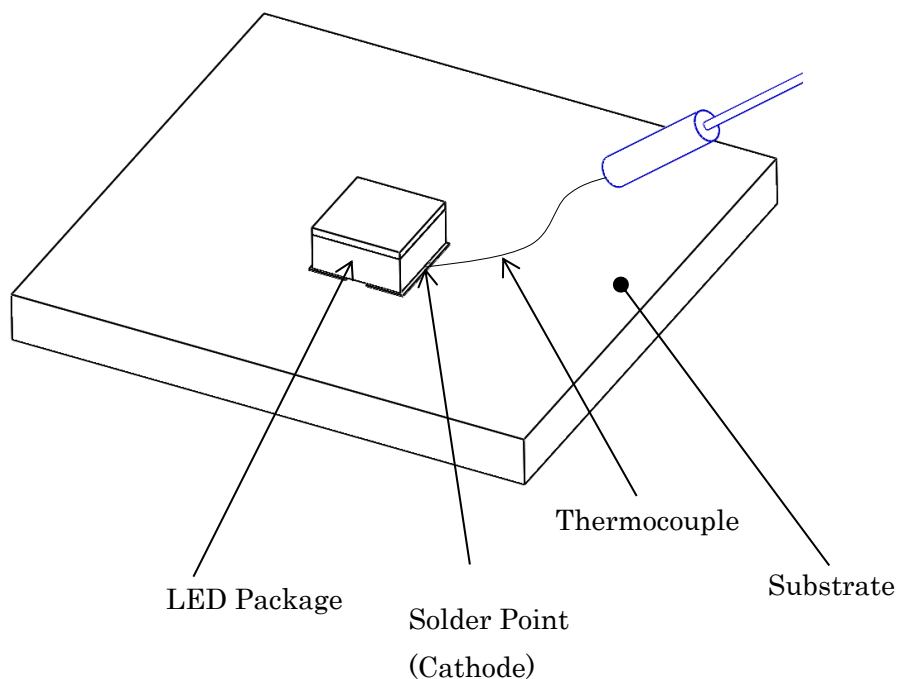

REFERENCE DRAWING: Measurement of Solder Point Temperature

## (G) Handling

- 1) Absolute maximum ratings conditions are not the conditions where the product reliability is guaranteed during operation. Operating conditions outside the derating curve may cause the products to degrade, leading to the decreased product reliability. Set the operating conditions so as not to go over the derating curve even for a moment.
- 2) Do not handle the products with bare hands. It will contaminate the product surface and may affect the optical characteristics.
- 3) Do not stack assembled PCBs together. The impact may cause the products to be scratched, chipped, delaminated and/or deformed, affecting the optical characteristics. In the worst case, it may cause an open circuit and complete failure of the products.
- 4) A vacuum tweezer is recommended for handling of this product. When handling with normal tweezers, do not pick the glass material. Wear safety glasses to prevent damage to the eyes from the chipped or broken glass material.
- 5) Insufficient flux cleaning will leave flux residue, which will absorb moisture during prolonged use and may cause leakage current or corrosion of electrodes.
- 6) Higher junction temperature may cause lowering product performance and/or product failure. Well-designed PCBs must be selected so as to properly dissipate the heat from the products.
- 7) Refer to the label of the shipping box surface to know the correct box orientation. Keeping the products in the wrong orientation may cause unwanted force and destroy the product.
- 8) Throwing or dropping the shipping box may cause the product inside to be broken.
- 9) Be careful when carrying the product after unboxing. Vibration or impact may cause the detachment and/or crack of glass material.
- 10) To protect the products from the electrostatic charge generated by vibration in transportation, use anti-static bags or cases. Anti-static measures must be taken even for short time/distance transportation.
- 11) The products may be exposed to a tough environment in shipment. Please take appropriate measures against moisture, mechanical impact and vibration, such as moisture barrier bags, hermetic containers and shock-absorbing materials.
- 12) Exposure to water or saltwater may cause a short circuit. The electrodes may also corrode leading to failure of the products.
- 13) Since the product temperature may rise due to the self-heating, do not touch the product during operation or just after shutting down.
- 14) Since the heat from this product may heat up the surrounding objects, heat-resistive materials are recommended to be used in the equipment including this product.
- 15) When using several LEDs at the same time, design the circuit so that each LED will not operate with a condition over the absolute maximum ratings. It is recommended that each LED be operated with constant current.

- 16) This product also emits visible light, which may be a hindrance for certain applications. Make sure before the usage that this does not cause a problem.
- 17) When operating the product outdoors, carefully carry out the operation verification tests considering the climatic shift at the point of use.
- 18) Do not wipe the product as the glass material could fall off.
- 19) Do not use ultrasonic cleaning.

(H) Installation on PCBs

- 1) Use of Cu-based PCB is recommended. Inappropriate size, array density, or layout of the product could lead to the detachment and/or crack of the glass material. Check in advance that the designed PCB can be properly used.
- 2) Separation of PCBs installed with this product or other parts must be performed in a way that any flexure or torsional stress is not applied to the PCBs. The layout of this product must be carefully designed to avoid the stress onto this product.
- 3) Separation of PCBs must be performed using PCB separators or special jigs to avoid tensile stress. Tensile stress may cause the detachment of the glass material.
- 4) This product is subject to the stress from the PCB since it's installed directly on the PCB. Inappropriate amount of solder paste could lead to solder crack or product detachment.
- 5) Materials of PCBs could be metal, fiber-reinforced plastics, phenolic paper, ceramics, and so on. PCBs must be designed from the viewpoint of thermal expansion, mechanical properties, and thermal management. Metal-based PCBs are often used for its high thermal conductivity. On the other hand, its large thermal expansion coefficient causes the large stress on this product. Carefully design the PCB to avoid the detachment and/or crack of the glass material.
- 6) Large soldering pad pattern requires more solder paste, which increases the potential for solder crack. Refer to the recommended soldering pad pattern described in "Outline Dimensions, Main Materials and Electric Circuit" section above.

(I) Ultraviolet (UV)

- 1) Do not look directly into the operating deep-ultraviolet LED as it may cause damage to the eyes. If looking into the operating LED is necessary, be sure to wear ultraviolet light protective glasses.
- 2) IEC62471 “Photobiological Safety of Lamps and Lamp Systems” defines exposure limits of electromagnetic radiation in the wavelength range from 200 nm to 3000 nm for each possible hazard (to the skin, eye, and retina). The deep ultraviolet light emitted from this product can be classified as belonging to the following hazards. It is recommended to understand the content of the standard before using the product.

Relevant Hazards

- Hazard to the skin
  - 4.3.1Es Actinic UV hazard exposure limit for the skin and eye
- Hazard to the eye (cornea)
  - 4.3.1Es Actinic UV hazard exposure limit for the skin and eye
  - 4.3.2Euva Near-UV hazard exposure limit for the eye
- Hazard to the retina
  - 4.3.3Lb Retina blue light hazard exposure limit
  - 4.3.4Eb Retina blue light hazard exposure limit – small source

(J) Others

- 1) This product is intended to be used for a general purpose (industry or consumer equipment). Consult Nikkiso’s sales staff in advance for information on more specialized applications in which higher quality is required (power plant application, submarine equipment, space equipment, aircraft equipment, medical equipment, transport equipment, emergency equipment etc.).
- 2) The customer shall not reverse engineer by disassembling or analysis of the LEDs without having prior written consent from Nikkiso. When defective LEDs are found, the customer shall inform Nikkiso directly before disassembling or analysis.